



RENTHAL®

**PRODUCT
INFORMATION**

2020



**PARTS
EUROPE**

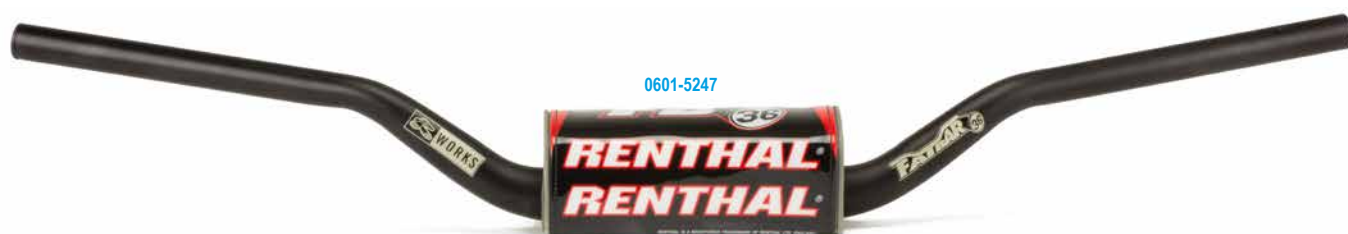

R-WORKS FATBAR36

- Ultimate lightweight motocross handlebar
- Constructed of new, proprietary Zarilium™
- Designed using Renthal's new 36Tech™ technology to maintain strength of existing Fatbar while reducing weight 36%
- Work with standard controls; ends taper down to 22 mm
- Require 36Tech™ bar mount clamps
- Bar pad included

HANDLEBAR DIMENSIONS

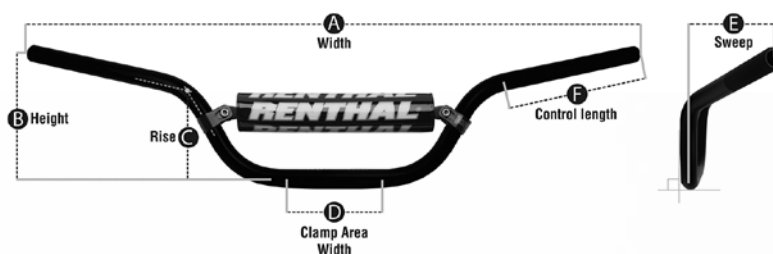

BEND	FATBAR36 BEND	A - WIDTH (MM)	B - HEIGHT (MM)	C - RISE (MM)	D - BASE (MM)	E - SWEEP (MM)	F - CONTROL LENGTH	TWINWALL BEND #	FATBAR BEND #	PART #
RC/HONDA CRF	930	804	104	60	130	54	197	997	604	0601-5247
KTM125/450	931	803	98	68	124	56	202	998	603	0601-5248
Reed / Windham	933	807	93	51	130	49	202	996	827	0601-5249
SX/SXF 09-12 / RM/RMZ	934	806	85	48	124	56	202	-	672	0601-5250

BM = vertical measurement from center line of mounting diameter to the end of the bars.

BV = vertical measurement from the baseline to the end of the bars.



36TECH BAR MOUNT CLAMPS

DESCRIPTION	FEATURE	PART #
CR/CRF (all) / KXF 2017-20 / YZ250F & WR-F 2017-20 / YZ450F 2017 & 2020 only	5 mm offset	0603-0923
CR/CRF (all) / KXF 2017-20 / YZ250F & WR-F 2017-20 / YZ450F 2017 & 2020 only	Zero offset	0603-0924
YZ450F 2018-19 with conical rubbers	-	0603-0929
YZ250 2017-20, YZ125 2017-20 Hard mounted in top yoke	5 mm offset	0603-0926
KTM SX,SX-F 2017-20 / Husqvarna FC, TC, TX 2018-20	Utilizes OE spacer nut 79001037034	0602-0927
KTM EXC, EXCF, SX 85 / Husqvarna FC, TC, TX to 2017 & FE, TE, FX, FS, TC85	Tram rail style	0603-0928
Suzuki RM/RMZ (all)	Zero offset / 10 mm bolt	0603-0925



FATBAR36 OVERVIEW

Working alongside factory race teams Renthal developed the concept to improve performance through weight reduction without compromising existing handlebar strength. Every time you accelerate, brake, corner, jump you work against the weight of the motorcycle. By reducing weight, it improves the performance of your motorcycle in all of these areas resulting in faster lap times.

Renthal has employed its 50+ years of experience in handlebar design, testing and racing to develop the R-Works Fatbar36 the ultimate in lightweight motocross handlebars. Utilising Renthal's 36Tech™ handlebar standard and proprietary Zarilium™ material to give a high strength handlebar at the lowest possible weight. The R-Works Fatbar®36 is 36% lighter than the standard 28 mm diameter Fatbar®, previously the lightest motocross handlebar.

LIGHTEST MOTOCROSS HANDLEBAR

Renthal has always strived to produce the strongest, highest quality product. The current handlebar range is at a strength level the factory level teams feel it needs to be, but weight saving will always be high on their priority list. Renthal made this his priority as well in developing Fatbar36.



36TECH™ - ADVANCED TECHNOLOGY

36TECH™ is a new handlebar standard developed by Renthal to push forward the boundaries of handlebar technology. The 36 mm clamping diameter tapers down to a conventional 22 mm control section at each end, using advanced wall geometry, maximising material efficiencies in wall thickness along the entire length of the handlebar to reduce weight.



NEW MATERIAL – 20% STRONGER

Zarilium® is a new aluminium alloy exclusive to Renthal. This new alloy has 20% greater ultimate tensile strength, while maintaining the same elongation properties. This additional strength has allowed Renthal to achieve the maximum weight reduction possible whilst matching the best in class strength of the Renthal® 28 mm diameter Fatbar®.

WORLD CLASS TESTING

Renthal is at the forefront of handlebar testing. The only handlebar manufacturer using data acquisition and equipped with its own in house test facility. This perfectly positions Renthal to maximise it's 50+ years of handlebar design, development and championship winning race experience. The result is the best performing handlebars with unrivalled quality.

STATE-OF-THE-ART MANUFACTURING

As the globally leader in handlebar technology Renthal prides his self, not only on engineering abilities, but also its state-of-the-art manufacturing facility. Taking raw Zarilium tube Renthal puts it through a host of operations to turn it into Fatbar36.



R-WORKS®

The R-Works® badge represents uncompromising performance. It means Renthal has selected the ultimate materials and manufacturing processes to bring you the very best performance product they can. A fraction of a second. A few grams. A couple of millimetres. It all counts.



FATBAR™ HANDLEBARS

- 7010-T6 aluminum alloy, braceless design to reduce weight while maintaining an extremely high strength
- The braceless design allows for a comfortable level of flexibility
- 28,6 mm (1¹/₈") clamping area reduces slippage
- Laser-etched positioning grid; knurled clutch side bar end prevents grip slippage
- Shot-peened, anodized finish resists corrosion
- Each handlebar includes an updated injection molded foam bar pad for better protection and greater durability
- Require 28,6 mm (1¹/₈") bar mounts for bikes originally equipped with 22 mm (7¹/₈") bars (see next page)

HANDLEBAR DIMENSIONS

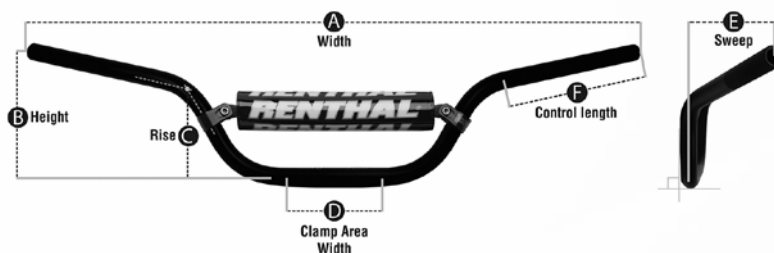

BEND	FATBAR BEND	BAR COLOR	A - WIDTH (MM)	B - HEIGHT (MM)	C - RISE (MM)	D - BASE (MM)	E - SWEEP (MM)	F - CONTROL LENGTH	PART #
SX/TC 85 13-	831	Black	779	88	53	122	50	200	0601-2435
	831	Orange	779	88	53	122	50	200	0601-4957
YZ65/85 19-20	842	Black	737	91	64	110	44	177	0601-1730
RC Mini / 85cc	671	Black	754	112	77	85	52	177	R67101BK
CRF 2018-	839	Black	802	91	51	131	51	200	0601-4696
	839	Titanium	802	91	51	131	51	200	0601-4697
	839	Red	802	91	51	131	51	200	0601-4698
Villipoto / Stewart / KTM 13-15	827	Black	811	92	52	117	52	222	0601-1965
	827	Titanium	811	92	52	117	52	222	0601-1966
	827	Orange	811	92	52	117	52	222	0601-4956
KTM High	826	Black	805	95	68	130	42	180	0601-1964
KTM Low	822	Black	808	83	53	140	41	200	0601-1963
McGrath / KTM 2016-	821	Black	813	78	42	150	54	200	0601-1442
	821	Titanium	813	78	42	150	54	200	0601-1443
	821	Orange	813	78	42	150	54	200	0601-4955
KTM 09-12 / RMZ 06-13 / YZF 18-20	672	Black	806	85	51	125	56	190	R67201BK
Ricky Carmichael High	609	Black	802	120	84	150	56	190	R60901BK
	609	Titanium	802	120	84	150	56	190	R60901TT
	609	Orange	802	120	84	150	56	190	0601-4950
CR High / Ricky Johnson	605	Black	805	97	64	115	65	200	R60501BK
RC / CRF 04-18 / KXF 06-20	604	Black	804	104	64	105	54	188	R60401BK
	604	Titanium	804	104	64	105	54	188	R60401TT
	604	Orange	804	104	64	105	54	188	0601-4949
	604	Blue	804	104	64	105	54	188	0601-0234
	604	Red	804	104	64	105	54	188	0601-0231
	604	Green	804	104	64	105	54	188	0601-3120
Reed / Windham	603	Black	800	98	74	100	55	187	R60301BK
	603	Titanium	800	98	74	100	55	187	R60301TT
YZ 07-20 / YZF 04-17	602	Black	801	88	59	125	56	193	0601-4946
	602	Titanium	801	88	59	125	56	193	0601-4948
	602	Blue	801	88	59	125	56	193	0601-4947
Enduro	745	Black	781	102	68	115	54	189	R74501BK
	745	Titanium	781	102	68	115	54	189	R74501TT

TWINWALL® & FATBAR™ BAR MOUNT CLAMPS

DESCRIPTION	FEATURE	PART #
HONDA CR-CRF 00-20 / KAWASAKI KX-KXF -08 RMZ 250 04-06 / YAMAHA YZ-F 14-20	5 mm	CL001
HONDA CR-CRF 00-20 / KAWASAKI KX-KXF -08 RMZ 250 04-06 / YAMAHA YZ-F 14-20	5 mm	CL002
SUZUKI RM -05, RMZ 07-20 / HVA -13	No	0603-0070
YAMAHA YZ/YZF 04-05	No	0603-0143
KAWASAKI KXF 09-20 / YAMAHA YZ-F & WR-F 10-13	5 mm	0603-0303
REPLACEMENT BOLT KIT		
M12 x 68 mm (for PART# 0603-0143 and 0603-0303)	-	2401-0580



CL001



0601-0151



0601-0152



0601-0153



0601-1489



0601-1490



0601-0034

FATBAR™ PADS

- For use with Fatbar™ handlebars
- High-density, injection-molded foam offers more protection
- Durable TPU cover with hook-and-loop fastener
- Power washer-proof permanent graphics
- Measures 25,5 cm L x 89 mm W x 70 mm H (10" x 3 1/2" x 2 3/4")



0601-4699



0601-3171

COLOR	PART #	COLOR	PART #	COLOR	PART #	COLOR	PART #
Orange	0601-0034	Blue	0601-0152	Green	0601-1489	Black/green/white	0601-4699
Red	0601-0151	Black	0601-0153	Yellow	0601-1490	Black/white/red	0601-3171



0601-2145



0601-2146



0601-2147



0601-2148



0601-3216

TEAM ISSUE FATBAR™ PADS

- Specially designed for use with Renthal Fatbar™ handlebars
- Feature unique shape offering greater coverage and distinct styling
- High-density, injected-molded foam
- Power washer-proof permanent graphics
- Measures 89 mm W x 25,5 cm x 70 mm H (3 1/2" x 10" x 2 3/4")

COLOR	PART #	COLOR	PART #	COLOR	PART #
Red	0601-2145	Orange	0601-2147	Black/white/red	0601-3216
Black	0601-2146	Blue	0601-2148		



HANDLEBARS



Black



Red



Blue



Titanium



Green



Orange

TWINWALL® HANDLEBARS

- Constructed of two aluminum alloy tubes, one inside the other
- Outer tube is 7010-T73, has extreme resistance to mechanical damage and is anodized to prevent corrosion
- Inner tube is ultra-high strength 7010-T6 aluminum, hard anodized to resist wear from twist grip and controls
- Rubber seals are used to cover the ends of the outer tube to keep water and cleaning fluids out
- Laser-marked in the middle for accurate positioning
- Available with anodized finish in your favorite racer's bend
- Each handlebar includes an updated injection-molded foam bar pad for better protection and greater durability
- Require 28,6 mm (1¹/₈") bar mounts for bikes originally equipped with 22 mm (7¹/₈") bars (see next page)

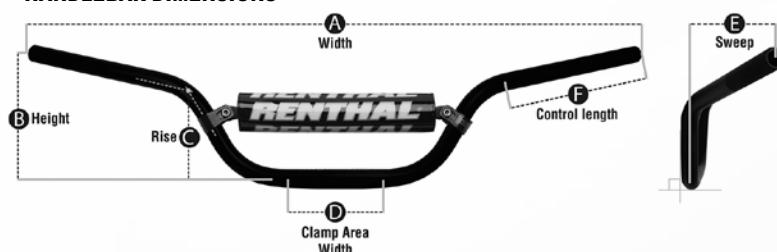
HANDLEBAR DIMENSIONS

BEND	TWINWALL BEND	BAR COLOR	A - WIDTH (MM)	B - HEIGHT (MM)	C - RISE (MM)	D - BASE (MM)	E - SWEEP (MM)	F - CONTROL LENGTH	PART #
RC 85cc / Mini cross	923	■ Black	754	112	80	80	40	170	0601-1633
McGrath / KTM 16+	999	■ Black	813	79	42	125	54	200	R99901BK
	999	■ Titanium	813	79	42	125	54	200	R9991HA
	999	■ Orange	813	79	42	125	54	200	0601-4962
Reed / Windham	998	■ Black	803	98	69	110	56	190	R99801BK
	998	■ Orange	803	98	69	110	56	190	0601-4961
Ricky Carmichael	997	■ Black	804	105	64	110	54	200	R99701BK
	997	■ Titanium	804	105	64	110	54	200	R9971HA
	997	■ Orange	804	105	64	110	54	200	0601-4960
	997	■ Blue	804	105	64	110	54	200	0601-0227
	997	■ Red	804	105	64	110	54	200	0601-0222
Villipoto / Stewart	997	■ Green	804	105	64	110	54	200	0601-3136
	996	■ Black	811	93	53	130	49	200	R99601BK
	996	■ Titanium	811	93	53	130	49	200	R9961HA
	996	■ Blue	811	93	53	130	49	200	0601-0226
	996	■ Orange	811	93	53	130	49	200	0601-4959
KTM High	996	■ Red	811	93	53	130	49	200	0601-0221
	994	■ Black	810	99	70	110	40	195	0601-0598
	994	■ Titanium	810	99	70	110	40	195	0601-0597
	994	■ Orange	810	99	70	110	40	195	0601-4958
	994	■ Blue	810	99	70	110	40	195	0601-3117
Ricky Carmichael High	922	■ Black	812	120	86	115	58	187	0601-0446
YZ/YZF 06+	921	■ Black	816	85	43	95	41	179	0601-0469
	921	■ Blue	816	85	43	95	41	179	0601-0470
CR High / Ricky Johnson	918	■ Black	801	99	67	115	65	192	R91801BK
	918	■ Titanium	801	99	67	115	65	192	R9951HA
	918	■ Blue	801	99	67	115	65	192	0601-0225



TWINWALL® & FATBAR™ BAR MOUNT CLAMPS

DESCRIPTION	FEATURE	PART #
HONDA CR-CRF 00-20 / KAWASAKI KX-KXF -08 RMZ 250 04-06 / YAMAHA YZ-F 14-20	5 mm	CL001
HONDA CR-CRF 00-20 / KAWASAKI KX-KXF -08 RMZ 250 04-06 / YAMAHA YZ-F 14-20	5 mm	CL002
SUZUKI RM -05, RMZ 07-20 / HVA -13	No	0603-0070
YAMAHA YZ/YZF 04-05	No	0603-0143
KAWASAKI KXF 09-20 / YAMAHA YZ-F & WR-F 10-13	5 mm	0603-0303
REPLACEMENT BOLT KIT		
M12 x 68 mm (for PART# 0603-0143 and 0603-0303)	-	2401-0580



CL001

0601-2150



0601-2151



0601-3188



0601-2152

TEAM ISSUE CROSSBAR PADS

- As used by the factory race teams
- Features the same injection-molded construction as standard pads
- Sold each

DESCRIPTION	PART #	DESCRIPTION	PART #	DESCRIPTION	PART #	DESCRIPTION	PART #
Black/red/green	0601-2150	Black/white/green	0601-2151	Black/white/yellow	0601-2152	Troy Lee design	0601-3188

C0311-BK



C0311-BU



C0611-GN



C0611-YL



0601-0148



0601-0458



0601-0145



0601-3851



0601-0461/0601-0460



SX CROSSBAR PADS

- Feature an injection-molded foam for better impact protection and significant increase in life span
- Sold each

COLOR	PART #	COLOR	PART #	COLOR	PART #	COLOR	PART #
21,5 CM (8½")		21,5 CM (8½") (CONT.)		25,5 CM (10") (CONT.)		25,5 CM (10") (CONT.)	
Black	C0311-BK	Black/red	0601-3170	Orange	0601-0148	White/red	0601-0459
Blue	C0311-BU	25,5 CM (10")		Red	C0611-RD	White/green	0601-0460
Red	0601-0145	Black	C0611-BK	Yellow	C0611-YL	Vintage, black/white/red	0601-3850
White/green	0601-0461	Blue	C0611-BU	White/blue	0601-0457	30,5 CM (12")	
Orange	0601-3169	Green	C0611-GN	Black/red	0601-0458	Vintage, black/white/red	0601-3851



22 MM (7/8") OFF-ROAD HANDLEBARS

- Exclusive aerospace aluminum alloy is precisely engineered for the best combination of strength and fatigue reduction
- Shot-peened finish for improved fatigue life
- Laser-marked positioning grid
- Exclusive, copyrighted lightweight clamping system for the cross brace; bolted and bonded to increase strength
- Special edition racer bars are dual-anodized in silver with colored ends
- Each handlebar includes an updated injection-molded foam bar pad for better protection and greater durability

HANDLEBAR DIMENSIONS

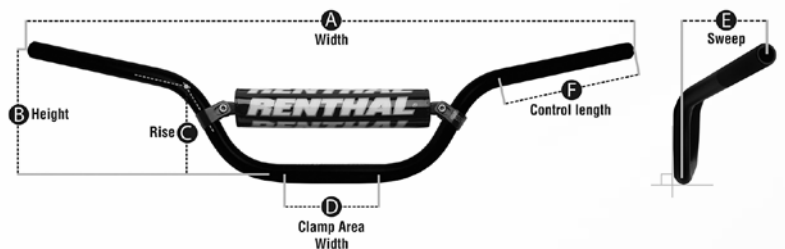

BEND	22 MM BEND	BAR COLOR	A - WIDTH (MM)	B - HEIGHT (MM)	C - RISE (MM)	D - BASE (MM)	E - SWEEP (MM)	F - CONTROL LENGTH	PART #
Pitbike 50cc	797	■ Black	715	196	190	60	42	158	0601-0451
	797	■ Silver	715	196	190	60	42	158	0601-0144
Pitbike 110cc	611	■ Black	740	151	118	120	67	190	0601-0454
	825	■ Black	670	80	64	90	49	165	0601-1847
KTM SX50	825	■ Orange	670	80	64	90	49	165	0601-2408
	823	■ Orange	744	80	72	110	49	180	0601-2407
KTM SX65	798	■ Black	775	92	64	115	49	196	0601-1927
KTM SX85	798	■ Orange	775	92	64	115	49	196	0601-4954
	784	■ Black	742	119	86	95	41	175	0601-1034
RC Mini / 85cc	784	■ Silver	742	119	86	95	41	175	R78403TT
	784	■ Orange	742	119	86	95	41	175	0601-4953
	783	■ Silver	738	117	87	95	53	173	R7831SC
KX65	780	■ Silver	737	101	85	95	67	173	R7801SI
KX80/85 98-	757	■ Silver	802	132	119	90	61	177	R7572SI
Mini High	983	■ Silver	808	95	58	150	55	206	R98305SI
Villipoto / Stewart RC	971	■ Black	802	97	62	135	53	201	0901-2409
	971	■ Silver	802	97	62	135	53	201	0601-3949
	971	■ Gold	802	97	62	135	53	201	R97108SG
	971	■ Red	802	97	62	135	53	201	0601-3948
	971	■ Green	802	97	62	135	53	201	0601-3034
	971	■ Titanium	807	88	61	135	60	203	R96605TT
Reed / Windham	966	■ Titanium	807	88	61	135	60	203	R96605TT
RC High	809	■ Silver	814	119	84	120	56	197	0601-0448
CR Low	790	■ Silver	803	82	53	135	57	202	R79002SI
CR High	722	■ Black	800	95	67	125	63	195	R7221BK
Enduro	693	■ Black	794	101	65	120	73	200	0601-3947
Enduro High	613	■ Black	835	135	95	130	78	192	0601-3945
	613	■ Silver	835	135	95	130	78	192	0601-3946
Vintage High	838	■ Silver	840	155	112	170	88	180	0601-3591
Vintage Mid	837	■ Silver	874	145	78	170	120	220	0601-3590
Vintage / Desert	666	■ Silver	850	119	82	140	74	197	R6662SI



REINFORCED DUAL-COMPOUND GRIPS

- Reinforced with aramid resin particles
- Resist wear while maintaining tacky feel
- Half-waffle design
- Available in standard and tapered style
- Sold in pairs

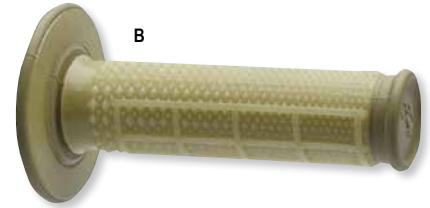
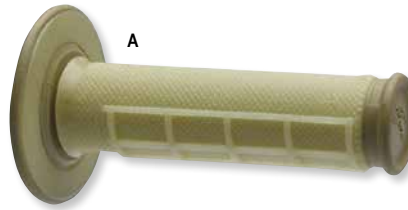

DESCRIPTION	PART #	DESCRIPTION	PART #
(A) Dual compound	0630-0265	(B) Dual compound tapered	0630-0266

ULTRA TACKY™ DUAL COMPOUND GRIPS

- Developed to increase traction between the glove and grip, increasing control and reducing rider fatigue
- Unique Ultra-Tacky™ compound constantly produces and renews a sticky surface coating
- Combine with Renthal® soft compound for comfortable and incredibly grippy surface

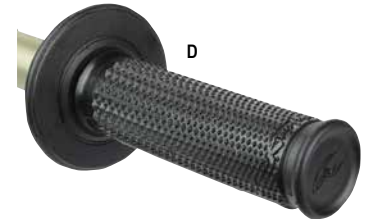

- Sticky surface lasts for the lifetime of the grip; wash with clean water and air dry to re-activate stickiness
- Sold in pairs

DESCRIPTION	PART #	DESCRIPTION	PART #
(C) Dual compound half waffle, black-on-black	0630-1695	(D) Dual compound half waffle, black-on-black; tapered	0630-1696

FULL-DIAMOND MX GRIPS

- Firm compound; same as stock
- Medium compound for better traction and comfort
- Soft compound ideal for maximum traction
- For use with twist throttles
- Sold in pairs

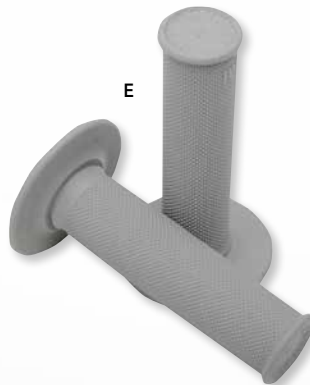

DESCRIPTION	PART #	DESCRIPTION	PART #	DESCRIPTION	PART #
(E) Soft	RG04S	(F) Medium	RG04M	(G) Firm	RG04F

FULL-WAFFLE GRIPS

- Designed after the CR Honda grip
- Available in soft, medium and firm compounds
- For use with twist throttles
- Sold in pairs

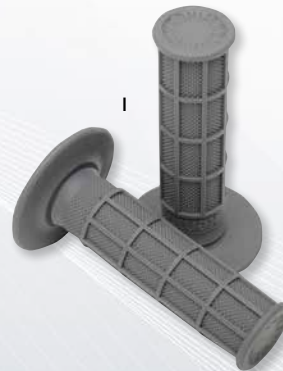
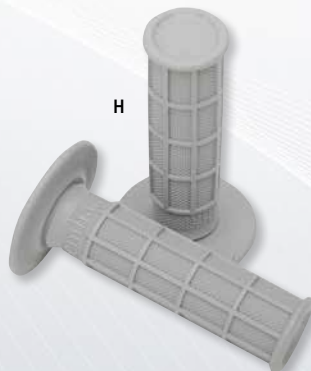

DESCRIPTION	PART #	DESCRIPTION	PART #	DESCRIPTION	PART #
(H) Soft	RG01S	(I) Medium	RG01M	(J) Firm	RG01F

HALF-WAFFLE GRIPS

- Waffle pattern in finger area for traction, smooth on palm side to reduce blisters
- Available in soft, medium and firm compounds
- Use with twist throttles
- Sold in pairs



DESCRIPTION	PART #	DESCRIPTION	PART #	DESCRIPTION	PART #
(K) Soft	RG025	(L) Medium	RG02M	(M) Firm	RG02F

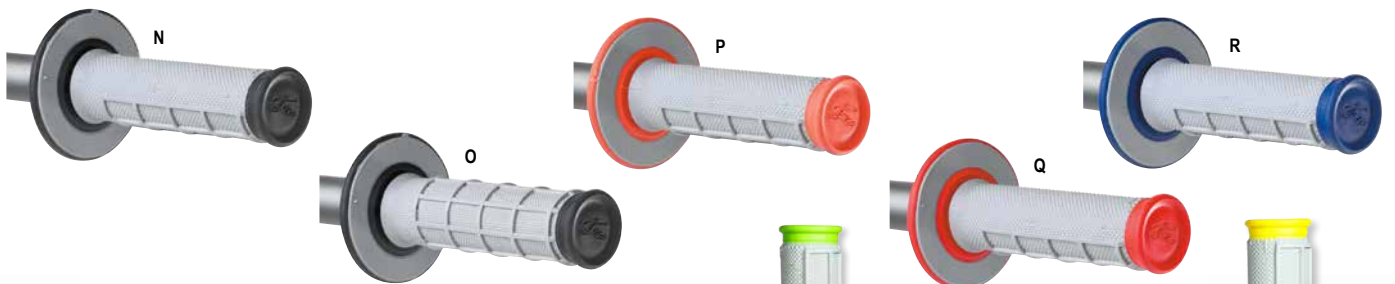

DUAL-COMPOUND GRIPS

- Combine the durability of Renthal firm compound grips with the feel and absorption qualities of the Renthal range of softer compound grips
- Firm compound used for the flange, inner sleeve and outer-end of the grip for maximum durability; softer compounds are used for the outer diameter of the grip, which is in direct contact with the palm, fingers and thumb
- For use with twist throttle
- Sold in pairs

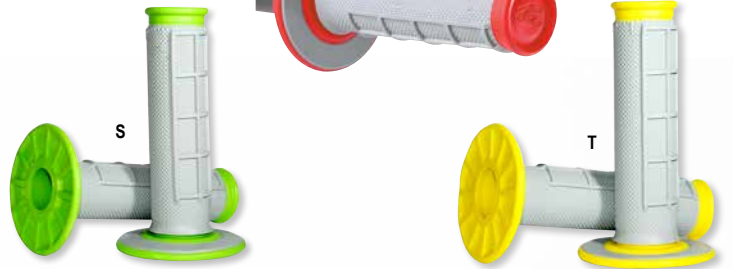

DESCRIPTION	COLOR	PART #	DESCRIPTION	COLOR	PART #	DESCRIPTION	COLOR	PART #
(N) Half waffle	Gray	RG151	(Q) Half waffle	Red	0630-0007	(T) Half waffle	Yellow	0630-1638
(O) Full waffle	Gray	RG152	(R) Half waffle	Blue	0630-0008			
(P) Half waffle	Orange	0630-0006	(S) Half waffle	Green	0630-1637			

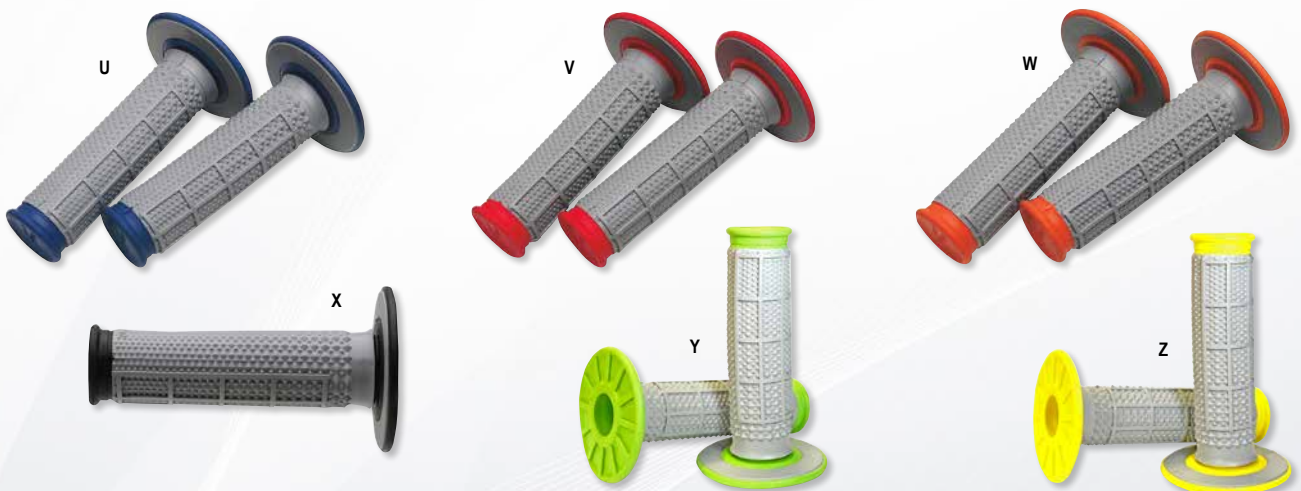

TAPERED DUAL-COMPOUND GRIPS

- Oversized thumb diameter tapers to standard size at end to match contours of a closed fist for maximum comfort and control
- Increased material in thumb area for more cushioning and damping against vibration without reducing control
- Soft compound used for the outer diameter of the grip, which is in direct contact with the palm, fingers and thumb
- Firm compound used for the flange, inner sleeve and outer-end of the grip for maximum durability
- Offer the ultimate combination of comfort and durability
- For use with twist throttle
- Sold in pairs

COLOR	PART #	COLOR	PART #	COLOR	PART #
(U) Blue	0630-0262	(W) Orange	0630-0264	(Y) Green	0630-1639
(V) Red	0630-0263	(X) Gray	RG154	(Z) Yellow	0630-1640

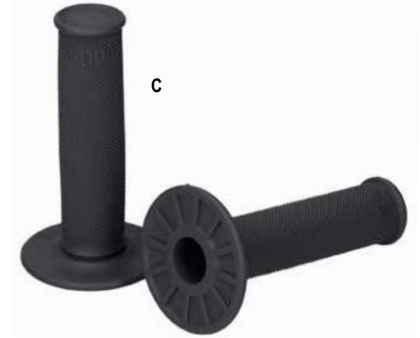
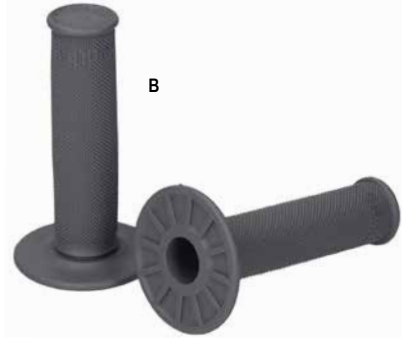
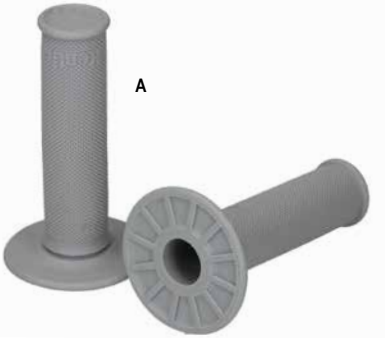

TRIAL GRIPS DIAMOND

- Renthal trials grips have been an industry standard and have been used by more world champions than any other grip on the market.
- Available in three advanced rubber compounds, soft, medium and firm, the trials grips feature a smaller inner flange and an all diamond pattern for the greatest amount of tackiness, shock absorption and feel.

DESCRIPTION	PART #	DESCRIPTION	PART #	DESCRIPTION	PART #
(A) Soft	0630-2676	(B) Medium	0630-2677	(C) Firm	0630-2678



CLEAN GRIP COVERS

- Protect grip while performing maintenance
- Hook-and-loop holds covers in place
- Sold as a pair

DESCRIPTION	PART #
Clean grip covers	0633-0020

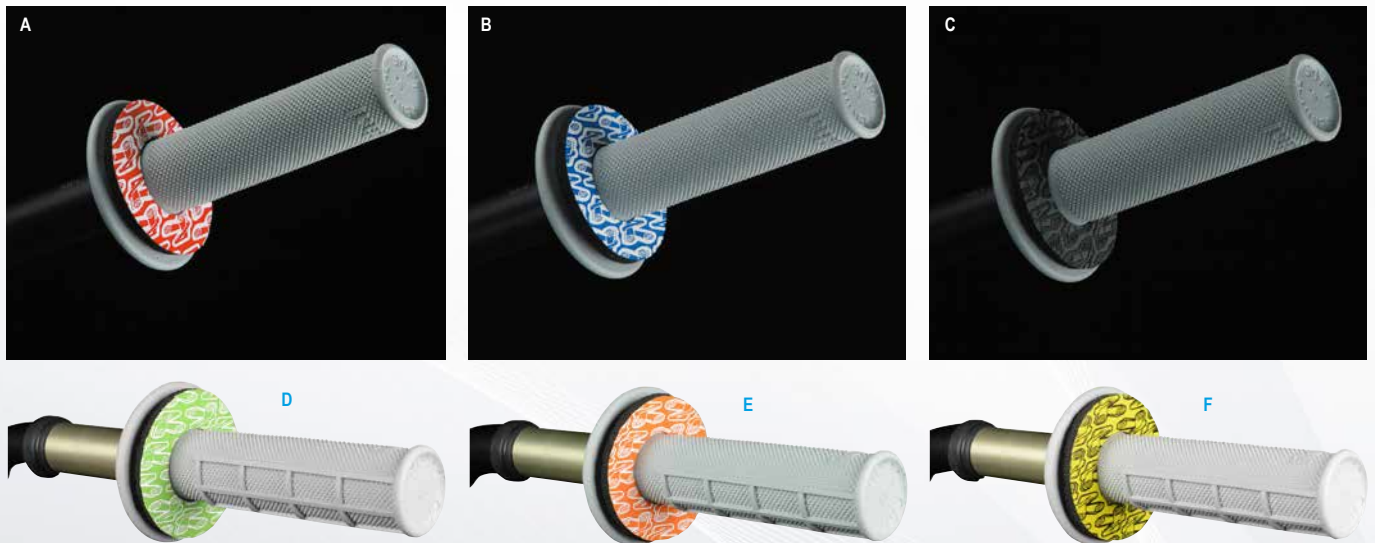

GRIP DONUTZ

- Help prevent blisters
- Add a cool factory look
- Sold in pairs

COLOR	PART #	COLOR	PART #	COLOR	PART #
(A) Red	0630-0079	(C) Gray	0630-0081	(E) White on orange	0630-2085
(B) Blue	0630-0080	(D) White on green	0630-2084	(F) Black on yellow	0630-2086



MOTO HANDGUARDS

- Excellent protection against rocks and roost
- Lightweight, dual-compound molded plastic shield with flexible synthetic rubber edge
- Reinforced composite plastic mounting bracket offers protection and allows guard to flex in the event of a crash
- Mounts independently of perches for versatility and does not interfere with controls
- Includes blue, black and red sticker kits
- Sold in pairs

DESCRIPTION	PART #	DESCRIPTION	PART #	DESCRIPTION	PART #	DESCRIPTION	PART #
(A) <input type="checkbox"/> White	0635-0877	(C) <input type="checkbox"/> Orange	0635-1572	(E) <input type="checkbox"/> Yellow	0635-1574	(G) <input type="checkbox"/> Red	0635-1576
(B) <input type="checkbox"/> Black	0635-1571	(D) <input type="checkbox"/> Green	0635-1573	(F) <input type="checkbox"/> Blue	0635-1575	(H) Repl. bracket	0635-0894



RC-1 WORKS BRAKE PADS SINTERED

- Premium high-performance sintered metal brake pads designed specifically for motocross and off-road racing applications
- Combine excellent wet and dry braking performance with maximum stopping power
- Sintered-metal compound is made from nine different materials to help reduce brake fade
- Specially formulated for quick bed-in time and immediate response
- Ceramic heat shield backing reduces overheating of the brake fluid
- Inter-granular graphite structure helps prevent brake noise
- Vacuum Press Furnace (VPF) production ensures a consistent density throughout the entire pad which helps maintain a high level of performance for the life of the pad

FITS MODEL	FRONT	REAR
BETA		
250RR 05-12	1721-0776	1721-0780
250RR 2 Stroke 13-13	1721-0776	1721-0780
300RR 2 Stroke 13-15	1721-0776	1721-0780
350RR 11-12	1721-0776	1721-0779
400RR 10-12	1721-0776	1721-0780
400RR 05-09	1721-0776	1721-0780
430RR 13-15	1721-0776	1721-0780
450RR 10-12	1721-0776	1721-0780
450RR 05-09	1721-0776	1721-0780
480RR 13-15	1721-0776	1721-0780
498RR 12-12	1721-0776	1721-0780
520RR 10-11	1721-0776	1721-0780
520RR 05-09	1721-0776	1721-0780
525RR 05-09	1721-0776	1721-0780
ALP 125/200/349 4T 05-15	-	1721-0780
RE & RR 125 4T 09-14	-	1721-0780
RR 2t Enduro 250 17-17	1721-0776	1721-0780
RR 2t Enduro 300 17-17	1721-0776	1721-0780
X-Trainer 300 18-18	1721-0776	1721-0780
X-Trainer 300 15-17	1721-0776	1721-0780
GAS GAS		
EC 125 Enduro 10-15	1721-0776	1721-0780
EC 125 Enduro 99-09	1721-0776	1721-0779
EC 125 Enduro 97-98	1721-0783	-
EC 200 19-19	1721-0776	1721-0780
EC 200 18-18	1721-0776	1721-0780
EC 200 Enduro 03-15	1721-0776	1721-0779
EC 200 Enduro 03-09	1721-0776	1721-0779
EC 200 Enduro 02-03	1721-0776	1721-0779
EC 200 Enduro 99-01	1721-0776	1721-0779
EC 250 19-19	1721-0776	1721-0780
EC 250 18-18	1721-0776	1721-0780
EC 250/300 18-18	1721-0776	1721-0780

FITS MODEL	FRONT	REAR
GAS GAS (CONT.)		
EC 250-300 Enduro 10-15	1721-0776	1721-0780
EC 250-300 Enduro 97-09	1721-0776	1721-0779
EC 300 19-19	1721-0776	1721-0780
EC 300 18-18	1721-0776	1721-0780
EC 515 09-09	1721-0776	1721-0779
ECF250F 13-15	1721-0776	1721-0780
ECF300F 13-15	1721-0776	1721-0780
ECF450F 13-15	1721-0776	1721-0780
Enduro GP 250 18-18	1721-0776	1721-0780
Enduro GP 300 18-18	1721-0776	1721-0780
SM 450 09-09	-	1721-0779
XC 200 19-19	1721-0776	1721-0780
XC 200 18-18	1721-0776	1721-0780
XC 250 19-19	1721-0776	1721-0780
XC 250 18-18	1721-0776	1721-0780
XC 250/300 18-18	1721-0776	1721-0780
XC 300 19-19	1721-0776	1721-0780
XC 300 18-18	1721-0776	1721-0780
HONDA		
CR 80R 86-95	1721-0778	-
CR 80/85 96-07	1721-0778	1721-0779
CR 125R 97-07	1721-0776	1721-0777
CR 250R 87-95	-	1721-0779
CR 250R 96-08	1721-0776	1721-0777
CR 500R 92-01	1721-0776	1721-0779
CRF 125F 18-20	1721-0776	-
CRF 150F 03-17	1721-0776	-
CRF 150R 07-20	1721-0778	1721-0777
CRF 230F 03-19	1721-0776	-
CRF 250F 19-20	1721-0776	1721-0777
CRF 250R 04-20	1721-0776	1721-0777
CRF 250RX 19-20	1721-0776	1721-0777
CRF 250X 04-16	1721-0776	1721-0777

FITS MODEL	FRONT	REAR
HONDA (CONT.)		
CRF 450R 02-20	1721-0776	1721-0777
CRF 450RWE 19-20	1721-0776	1721-0777
CRF 450RX 17-20	1721-0776	1721-0777
CRF 450X 05-09	1721-0776	1721-0777
CRF 450X 12-17	1721-0776	1721-0777
CRF 450X 19-20	1721-0776	1721-0777
XR 250R 90-05	-	1721-0779
XR 400R 96-04	1721-0776	-
XR 600R 91-91	-	1721-0779
XR 600R 92-00	1721-0776	1721-0779
XR 650L 93-09	1721-0776	1721-0779
XR 650L 12-12	1721-0776	1721-0779
XR 650L 19-19	1721-0776	1721-0779
XR 650R 00-07	1721-0776	1721-0779
HUSABERG		
FE 250 13-14	1721-0783	1721-0784
FE 350 13-14	1721-0783	1721-0784
FE 390 10-12	1721-0783	1721-0784
FE 450E 09-13	1721-0783	1721-0784
FE 450E 06-07	1721-0783	-
FE 501 13-15	1721-0783	1721-0784
FE 550 06-07	1721-0783	-
FE 570 09-12	1721-0783	1721-0784
FE 650E 06-07	1721-0783	-
FX 450 10-12	1721-0783	1721-0784
TE 125 13-14	1721-0783	1721-0784
TE 250 12-14	1721-0783	1721-0784
TE 300 12-14	1721-0783	1721-0784
HUSQVARNA		
CR 65 11-12	1721-0788	1721-1343
CR 125 95-96	1721-0783	-
CR 125 98-12	1721-0783	1721-0784
CR 250 00-04	1721-0783	-



FRONT SPROCKETS

- CNC-machined from case hardened and core refined 655M13 nickel chromium steel
- Machined self-cleaning mud grooves at each tooth to help prevent mud buildup and increase wear resistance
- Certain models available in ultralight design for a 10-15% weight savings

REAR SPROCKETS

- CNC-machined from a specially enhanced 7075-T6 aluminum alloy
- Machined self-cleaning mud grooves at each tooth to help prevent mud buildup and increase wear resistance
- Ultralight design is 66% lighter than steel, yet incredibly durable
- Silver available for all models; black, blue, red and orange anodized finish available for certain models
- #1 sprocket used in supercross, motocross and offroad throughout the world

FITS MODEL	GEARING	FRONT SIZE	PART #	REAR SIZE	PART#	OPTIONAL COLOR
BETA						
200/250/270 REV3 03-05	-	11T	1212-1676	41T	1211-2518 ¹	■ Aluminum
200/250/270 REV3 05-08	-			42T	1211-2523 ¹	■ Aluminum
250 EVO-2 09-12						
250/300 EVO-4 09-12						
250/300 EVO-4 13						
RR 250 05-07	14/52	11T	1212-1300	46T	1211-2528 ¹	■ Aluminum
RR 400/450/525 05-09	14/50	12T	1212-1660	47T	1211-1139	■ Aluminum
RR 350/390/400 10-20	13/50	13T	R292-520-13	48T	1211-1140	■ Aluminum
RR 450/498/520 10-20	13/48	13T	1212-0884 ¹	49T	1211-1141	■ Aluminum
		14T	R292-520-14	50T	1211-1142	■ Aluminum
		14T	1212-0885 ¹	51T	1211-1143	■ Aluminum
		15T	1212-0046	52T	1211-1144	■ Aluminum
GAS GAS						
EC125 Enduro 99-15	-	-	-	46T	1211-2528 ¹	■ Aluminum
				47T	1211-1139	■ Aluminum
				48T	1211-1140	■ Aluminum
				49T	1211-1141	■ Aluminum
				50T	1211-1142	■ Aluminum
				51T	1211-1143	■ Aluminum
				52T	1211-1144	■ Aluminum
EC200 Enduro 99-03	13/51	12T	1212-1651	46T	1211-2528 ¹	■ Aluminum
EC200 03-20	12/50	13T	1212-1639	47T	1211-1139	■ Aluminum
EC250-300 97-15	13/48			48T	1211-1140	■ Aluminum
GP 250/300 18	13/48			49T	1211-1141	■ Aluminum
EC250 18-20	13/48			50T	1211-1142	■ Aluminum
EC/XC250/300 18-20	13/48			51T	1211-1143	■ Aluminum
FSE 400/450 Enduro 02-12	13/48			52T	1211-1144	■ Aluminum
SM450 09	13/42					
EC515 09	13/48					
SM515 08-09	13/42					
ECF 250F 13-15	13/48	13T	1212-0991	46T	1211-2528 ¹	■ Aluminum
ECF 300F 13-15		14T	1212-0992	47T	1211-1139	■ Aluminum
				48T	1211-1140	■ Aluminum
				49T	1211-1141	■ Aluminum
				50T	1211-1142	■ Aluminum
				51T	1211-1143	■ Aluminum
				52T	1211-1144	■ Aluminum

¹ Ultralight

FITS MODEL	GEARING	FRONT SIZE	PART #	REAR SIZE	PART#	OPTIONAL COLOR
GAS GAS (CONT.)						
TXT 125 Racing 17-18	09/49	10T	1212-1652	41T	1211-2518 ¹	■ Aluminum
TXT GP 125 18	09/49	11T	1212-1583	42T	1211-2523 ¹	■ Aluminum
Trials Pro 200 02-11	-	11T	1212-1653			
Trials Pro 250 02-15	11/41					
TXT 250 Racing 17-18	09/41					
Trials Pro 280 to 300 02-15	11/41					
TXT GP 250 18	09/49					
TXT 280/300 Racing 17-18	-					
TXT GP 250/300 18	-					
ECF 450F 13-15	13/48	12T	R289-520-12	46T	1211-2528 ¹	■ Aluminum
		13T	R289-520-13	47T	1211-1139	■ Aluminum
		13T	1212-1638 ¹	48T	1211-1140	■ Aluminum
		14T	R289-520-14	49T	1211-1141	■ Aluminum
		14T	R289U-520-14 ¹	50T	1211-1142	■ Aluminum
		15T	R289-520-15	51T	1211-1143	■ Aluminum
				52T	1211-1144	■ Aluminum
HONDA						
CRF50F 04-16	14/37	14T	R259-420-14	-	-	
CRF70F 04-12	15/36	15T	R259-420-15			
CR80R Small Wheels 86-02	15/49	14T	R259-420-14	49T	1211-0289	■ Red
CR80R Big Wheels 96-07	15/55	15T	R259-420-15	50T	1211-0290	■ Red
CR85R Small Wheels 03-04	15/49			55T	1211-0291	■ Red
CR85R Small Wheels 05-07	14/49			55T	R189-55	■ Aluminum
				56T	1211-0292	■ Red
				56T	R189-56	■ Aluminum
CR125R 87-96, 98-99, 02	13/51	12T	R256-520-12	44T	1211-2529 ¹	■ Aluminum
CR125R 97	12/49	13T	R256-520-13	45T	R154-45	■ Aluminum
CR125R 00-01	13/52			47T	R154-47	■ Aluminum
CR125R 03	13/52			48T	R154-48	■ Aluminum
CR125R 04	13/53	12T	1212-1658	48T	1211-0030	■ Black
CR125R 05-07	13/52	13T	1212-0024	48T	1211-0159	■ Red
		13T	1212-1634 ¹	49T	R154-49	■ Aluminum
		14T	1212-0025	49T	1211-0031	■ Black
		14T	1212-1633 ¹	49T	1211-0160	■ Red
				50T	R154-50	■ Aluminum
				50T	1211-0032	■ Black
				50T	1211-0161	■ Red
				51T	R154-51	■ Aluminum
				51T	1211-0033	■ Black
				51T	1211-0162	■ Red
				53T	R154-53	■ Aluminum
				53T	1211-0179	■ Black
				53T	1211-0180	■ Red
CRF150F 05-17	13/48	13T	1212-1662	47T	R154-47	■ Aluminum
CRF230F 03-17				48T	R154-48	■ Aluminum
				48T	1211-0030	■ Black
				48T	1211-0159	■ Red
				49T	R154-49	■ Aluminum
				49T	1211-0031	■ Black
				49T	1211-0160	■ Red
				50T	R154-50	■ Aluminum
				50T	1211-0032	■ Black
				50T	1211-0161	■ Red
CRF150RB 07-20	15/56	14T	1212-0285	49T	1211-0289	■ Red
CRF150R 07-20	15/50	15T	1212-0286	50T	1211-0290	■ Red
				55T	1211-0291	■ Red
				55T	R189-55	■ Aluminum
				56T	1211-0292	■ Red
				56T	R189-56	■ Aluminum
CRF250L/Rally 13-20	-	13T	1212-1677	40T	1211-1194	■ Aluminum
		14T	1212-0876	44T	1211-2527 ¹	■ Aluminum
				48T	1211-2514 ¹	■ Black
				48T	1211-2511 ¹	■ Red
				49T	1211-2513 ¹	■ Black
				49T	1211-2510 ¹	■ Red
				50T	1211-2512 ¹	■ Black
				50T	1211-2509 ¹	■ Red

¹ Ultralight



FITS MODEL	GEARING	FRONT SIZE	PART #	REAR SIZE	PART#	OPTIONAL COLOR
HONDA (CONT.)						
CR250R 88-91	14/51	13T	R253-520-13	44T	1211-2529 ¹	■ Aluminum
CR250R 92-95	13/49	13T	R253U-520-13 ¹	45T	R154-45	■ Aluminum
CR250R 96-01	13/50	14T	R253-520-14	47T	R154-47	■ Aluminum
CR250R 02-07	13/48	14T	1212-1636 ¹	48T	R154-48	■ Aluminum
				48T	1211-0030	■ Black
				48T	1211-0159	■ Red
				49T	R154-49	■ Aluminum
				49T	1211-0031	■ Black
				49T	1211-0160	■ Red
				50T	R154-50	■ Aluminum
				50T	1211-0032	■ Black
				50T	1211-0161	■ Red
				51T	R154-51	■ Aluminum
				51T	1211-0033	■ Black
				51T	1211-0162	■ Red
				53T	R154-53	■ Aluminum
				53T	1211-0179	■ Black
53T	1211-0180	■ Red				
CRF250M 91-95	-	-	-	40T	1211-1194	■ Aluminum
				44T	1211-2527 ¹	■ Aluminum
				48T	1211-2514 ¹	■ Black
				48T	1211-2511 ¹	■ Red
				49T	1211-2513 ¹	■ Black
				49T	1211-2510 ¹	■ Red
				50T	1211-2512 ¹	■ Black
50T	1211-2509 ¹	■ Red				
CRF250R 04-09	13/51	12T	1212-1658	44T	1211-2529 ¹	■ Aluminum
CRF250R 10	13/48	13T	1212-0024	45T	R154-45	■ Aluminum
CRF250R 11-17	13/49	13T	1212-1634 ¹	47T	R154-47	■ Aluminum
CRF250X 04-15	14/53	14T	1212-0025	48T	R154-48	■ Aluminum
				48T	1211-0030	■ Black
				48T	1211-0159	■ Red
				49T	R154-49	■ Aluminum
				49T	1211-0031	■ Black
				49T	1211-0160	■ Red
				50T	R154-50	■ Aluminum
				50T	1211-0032	■ Black
				50T	1211-0161	■ Red
				51T	R154-51	■ Aluminum
51T	1211-0033	■ Black				
51T	1211-0162	■ Red				
53T	R154-53	■ Aluminum				
53T	1211-0179	■ Black				
53T	1211-0180	■ Red				
CRF250R 18-20	12/49	12T	1212-1437	44T	1211-2529 ¹	■ Aluminum
				44T	1212-1438	■ Aluminum
				45T	R154-45	■ Aluminum
				47T	R154-47	■ Aluminum
				48T	R154-48	■ Aluminum
				48T	1211-0030	■ Black
				48T	1211-0159	■ Red
				49T	R154-49	■ Aluminum
				49T	1211-0031	■ Black
				49T	1211-0160	■ Red
				50T	R154-50	■ Aluminum
				50T	1211-0032	■ Black
				50T	1211-0161	■ Red
				51T	R154-51	■ Aluminum
51T	1211-0033	■ Black				
51T	1211-0162	■ Red				
53T	R154-53	■ Aluminum				
53T	1211-0179	■ Black				
53T	1211-0180	■ Red				
XR250R 96-05	13/48	13T	1212-1677	44T	1211-2529 ¹	■ Aluminum
				45T	R154-45	■ Aluminum
				47T	R154-47	■ Aluminum
				48T	R154-48	■ Aluminum
				48T	1211-0030	■ Black
				48T	1211-0159	■ Red
				49T	R154-49	■ Aluminum

¹ Ultralight

² Ultralight grooved

FITS MODEL	GEARING	FRONT SIZE	PART #	REAR SIZE	PART#	OPTIONAL COLOR
HONDA (CONT.)						
				49T	1211-0031	■ Black
				49T	1211-0160	■ Red
				50T	R154-50	■ Aluminum
				50T	1211-0032	■ Black
				50T	1211-0161	■ Red
				51T	R154-51	■ Aluminum
				51T	1211-0033	■ Black
				51T	1211-0162	■ Red
				53T	R154-53	■ Aluminum
				53T	1211-0179	■ Black
				53T	1211-0180	■ Red
XR400R 96-04				44T	1211-2529 ¹	■ Aluminum
				45T	R154-45	■ Aluminum
				47T	R154-47	■ Aluminum
				48T	R154-48	■ Aluminum
				48T	1211-0030	■ Black
				48T	1211-0159	■ Red
				49T	R154-49	■ Aluminum
				49T	1211-0031	■ Black
				49T	1211-0160	■ Red
				50T	R154-50	■ Aluminum
				50T	1211-0032	■ Black
				50T	1211-0161	■ Red
				51T	R154-51	■ Aluminum
				51T	1211-0033	■ Black
				51T	1211-0162	■ Red
				53T	R154-53	■ Aluminum
				53T	1211-0179	■ Black
				53T	1211-0180	■ Red
CRF450R 02-03	13/50	13T	R253-520-13	44T	1211-2529 ¹	■ Aluminum
CRF450R 04-18	13/48	13T	R253U-520-13 ¹	45T	R154-45	■ Aluminum
CRF450R/RX/RWE 19-20	13/49	14T	R253-520-14	47T	R154-47	■ Aluminum
CRF450X 05-17	13/51	14T	1212-1636 ¹	48T	R154-48	■ Aluminum
		15T	R253-520-15	48T	1211-0030	■ Black
				48T	1211-0159	■ Red
				49T	R154-49	■ Aluminum
				49T	1211-0031	■ Black
				49T	1211-0160	■ Red
				50T	R154-50	■ Aluminum
				50T	1211-0032	■ Black
				50T	1211-0161	■ Red
				51T	R154-51	■ Aluminum
				51T	1211-0033	■ Black
				51T	1211-0162	■ Red
				53T	R154-53	■ Aluminum
				53T	1211-0179	■ Black
				53T	1211-0180	■ Red
CR500R 88-91	14/51	13T	R253-520-13	44T	1211-2529 ¹	■ Aluminum
CR500R 92-01	14/49	13T	R253U-520-13 ¹	45T	R154-45	■ Aluminum
		14T	R253-520-14	47T	R154-47	■ Aluminum
		14T	1212-1636 ¹	48T	R154-48	■ Aluminum
		15T	R253-520-15	48T	1211-0030	■ Black
				48T	1211-0159	■ Red
				49T	R154-49	■ Aluminum
				49T	1211-0031	■ Black
				49T	1211-0160	■ Red
				50T	R154-50	■ Aluminum
				50T	1211-0032	■ Black
				50T	1211-0161	■ Red
				51T	R154-51	■ Aluminum
				51T	1211-0033	■ Black
				51T	1211-0162	■ Red
				53T	R154-53	■ Aluminum
				53T	1211-0179	■ Black
				53T	1211-0180	■ Red

¹ Ultralight



FITS MODEL	GEARING	FRONT SIZE	PART #	REAR SIZE	PART#	OPTIONAL COLOR
HONDA (CONT.)						
XR600R 92-00	-	-	-	40T	1211-1194	Aluminum
XR650L 93-20	-	-	-	44T	1211-2527 ¹	Aluminum
				48T	1211-2514 ¹	Black
				48T	1211-2511 ¹	Red
				49T	1211-2513 ¹	Black
				49T	1211-2510 ¹	Red
				50T	1211-2512 ¹	Black
				50T	1211-2509 ¹	Red
XR650R 00-07	-	-	-	44T	1211-2529 ¹	Aluminum
				45T	R154-45	Aluminum
				47T	R154-47	Aluminum
				48T	R154-48	Aluminum
				48T	1211-0030	Black
				48T	1211-0159	Red
				49T	R154-49	Aluminum
				49T	1211-0031	Black
				49T	1211-0160	Red
				50T	R154-50	Aluminum
				50T	1211-0032	Black
				50T	1211-0161	Red
				51T	R154-51	Aluminum
				51T	1211-0033	Black
				51T	1211-0162	Red
				53T	R154-53	Aluminum
				53T	1211-0179	Black
				53T	1211-0180	Red
HUSABERG						
TE 125 13-14		13T	1212-0884	45T	1211-0078	Aluminum
FE 250 13-14		14T	1212-0885	46T	1211-0079	Aluminum
TE 250 12-14				48T	R224-48	Aluminum
TE 300 12-14				48T	1211-0045	Black
FE 350 13-14				48T	1211-1343	Blue
FE 390 10-12				49T	1211-0046	Black
FE 450 09-14				49T	1211-1332	Blue
FE 450 04-08				50T	R224-50	Aluminum
FX 450 10-12				50T	1211-0047	Black
FE 501 13-15				50T	1211-1333	Blue
FE 570 09-12				51T	R224-51	Aluminum
FS 570 10-11				51T	1211-0048	Black
				51T	1211-1334	Blue
				52T	R224-52	Aluminum
				52T	1211-0049	Black
				53T	1211-0104	Aluminum
FE 450E 06-07		14T	1212-1654	45T	1211-0078	Aluminum
FS 450E 06-07				46T	1211-0079	Aluminum
FC 550 05-08				48T	R224-48	Aluminum
FE 550 06-07				48T	1211-0045	Black
				48T	1211-1343	Blue
				49T	1211-0046	Black
				49T	1211-1332	Blue
				50T	R224-50	Aluminum
				50T	1211-0047	Black
				50T	1211-1333	Blue
				51T	R224-51	Aluminum
				51T	1211-0048	Black
				51T	1211-1334	Blue
				52T	R224-52	Aluminum
				52T	1211-0049	Black
				53T	1211-0104	Aluminum
HUSQVARNA						
TC50 18-20	11/40	10T	1212-0825	36T	1211-1208	Black
		12T	1212-0827	38T	1211-1209	Black
				40T	1211-1210	Black
TC65 17-20		13T	1212-1584	46T	R192U-42046	Aluminum
	14/48	14T	1212-0708	48T	R192U-42048	Aluminum
				50T	1211-0087	Aluminum

¹ Ultralight



SPROCKETS

PARTS
EUROPE

FITS MODEL	GEARING	FRONT SIZE	PART #	REAR SIZE	PART#	OPTIONAL COLOR
HUSQVARNA (CONT.)						
TC85 14-17	14/49	13T	1212-1585	46T	1211-0088	■ Aluminum
		14T	1212-0828	46T	1211-1722	■ Blue
				47T	1211-0089	■ Aluminum
				47T	1211-1723	■ Blue
				48T	1211-0090	■ Aluminum
				48T	1211-1724	■ Blue
				49T	1211-0091	■ Aluminum
				49T	1211-1725	■ Blue
				50T	1211-0092	■ Aluminum
				50T	1211-1726	■ Blue
TC85 18-20	13/49	13T	1212-1458	46T	1211-0088	■ Aluminum
		14T	1212-1459	46T	1211-1722	■ Blue
				47T	1211-0089	■ Aluminum
				47T	1211-1723	■ Blue
				48T	1211-0090	■ Aluminum
				48T	1211-1724	■ Blue
				49T	1211-0091	■ Aluminum
				49T	1211-1725	■ Blue
				50T	1211-0092	■ Aluminum
				50T	1211-1726	■ Blue
CR125 90-94	12/50	12T	1212-1674	46T	1211-2528 ¹	■ Aluminum
SM125 99-08	13/50	13T	1212-0838 ¹	47T	1211-1139	■ Aluminum
		13T	1212-1673	48T	1211-1140	■ Aluminum
		14T	1212-0839	49T	1211-1141	■ Aluminum
		15T	1212-0840	50T	1211-1142	■ Aluminum
		51T	1211-1143	■ Aluminum		
52T	1211-1144	■ Aluminum				
TC/TE/FC/FE 125/250/300/350/450/501 14-20	14/50	11T	1212-1300	45T	1211-0078	■ Aluminum
		12T	1212-1660	46T	1211-0079	■ Aluminum
		13T	R292-520-13	48T	R224-48	■ Aluminum
		13T	1212-0884 ¹	48T	1211-0045	■ Black
		14T	R292-520-14	48T	1211-1343	■ Blue
		14T	1212-0885 ¹	49T	1211-0046	■ Black
		15T	1212-0046	49T	1211-1332	■ Blue
		50T	R224-50	■ Aluminum		
		50T	1211-0047	■ Black		
		50T	1211-1333	■ Blue		
		51T	R224-51	■ Aluminum		
		51T	1211-0048	■ Black		
		51T	1211-1334	■ Blue		
52T	R224-52	■ Aluminum				
52T	1211-0049	■ Black				
53T	1211-0104	■ Aluminum				
CR125 95-13	13/50	-	-	46T	1211-2528 ¹	■ Aluminum
WR125 95-97	13/52			47T	1211-1139	■ Aluminum
WR125 98-10	13/50			48T	1211-1140	■ Aluminum
WR125E 95-99	13/52			49T	1211-1141	■ Aluminum
				50T	1211-1142	■ Aluminum
				51T	1211-1143	■ Aluminum
				52T	1211-1144	■ Aluminum
CR250 92-94	14/48	12T	1212-1674	46T	1211-2528 ¹	■ Aluminum
CR250 99	15/50	13T	1212-0838 ²	47T	1211-1139	■ Aluminum
CR250 00-05	13/48	13T	1212-1673	48T	1211-1140	■ Aluminum
TC250 02-03	14/50	14T	1212-0839	49T	1211-1141	■ Aluminum
TC250 04-05	13/50	15T	1212-0840	50T	1211-1142	■ Aluminum
TC250 06-08	12/50			51T	1211-1143	■ Aluminum
				52T	1211-1144	■ Aluminum
CR250 95-98	13/48			46T	1211-2528 ¹	■ Aluminum
				47T	1211-1139	■ Aluminum
				48T	1211-1140	■ Aluminum
				49T	1211-1141	■ Aluminum
				50T	1211-1142	■ Aluminum
				51T	1211-1143	■ Aluminum
		52T	1211-1144	■ Aluminum		
TC250 09-12	12/50	12T	1212-0727	46T	1211-2528 ¹	■ Aluminum
TC250R 13	13/50	13T	1212-0728	47T	1211-1139	■ Aluminum
TE250 10-12	13/50			48T	1211-1140	■ Aluminum
TE310 11-12	12/50			49T	1211-1141	■ Aluminum
				50T	1211-1142	■ Aluminum
				51T	1211-1143	■ Aluminum
				52T	1211-1144	■ Aluminum

¹ Ultralight² Ultralight grooved



FITS MODEL	GEARING	FRONT SIZE	PART #	REAR SIZE	PART#	OPTIONAL COLOR
HUSQVARNA (CONT.)						
TE250 02-03	14/50	12T	1212-1674	46T	1211-2528¹	■ Aluminum
TE250 04-10	13/50	13T	1212-0838²	47T	1211-1139	■ Aluminum
TXC250 08-10	13/50	13T	1212-1673	48T	1211-1140	■ Aluminum
WR250 10	13/48	14T	1212-0839	49T	1211-1141	■ Aluminum
WR250E 92-98	14/48	15T	1212-0840	50T	1211-1142	■ Aluminum
WR250E 99-09	13/48			51T	1211-1143	■ Aluminum
TE310 09-10	13/50			52T	1211-1144	■ Aluminum
TE350 90-95	15/51					■ Aluminum
CR360 92-94	13/48	-	-	46T	1211-2528¹	■ Aluminum
WR360 92-98	13/48			47T	1211-1139	■ Aluminum
WR360 99-03	15/48			48T	1211-1140	■ Aluminum
				49T	1211-1141	■ Aluminum
				50T	1211-1142	■ Aluminum
				51T	1211-1143	■ Aluminum
				52T	1211-1144	■ Aluminum
TE400 01-02	15/50	12T	1212-1674	46T	1211-2528¹	■ Aluminum
TE410 95-00	15/48	13T	1212-0838²	47T	1211-1139	■ Aluminum
SM-R 450 03-04	15/45	13T	1212-1673	48T	1211-1140	■ Aluminum
SM-R 450 05	15/42	14T	1212-0839	49T	1211-1141	■ Aluminum
SM-RR 450 08-09	13/42	15T	1212-0840	50T	1211-1142	■ Aluminum
TC450 02-10	14/50			51T	1211-1143	■ Aluminum
TE450 07-10	13/47			52T	1211-1144	■ Aluminum
TXC450 08-10	13/47					
SM-R 510 05	16/42					
SM-R 510 06-09	15/42					
TC510 05	14/47					
TC510 06	14/50					
TC510 07-10	14/47					
TE510 06-10	13/47					
TXC510 09-10	13/47					
SM-R 570 01-04	16/48					
TC570 01-03	14/52					
TE570 01-04	17/48					
SM610 08-09	15/43					
SM-S 610 00-08	16/45					
TC610 91-97	12/52					
TC610 98	13/52					
TC610 99-00	14/52					
TE610 91-01	17/48					
TE610 08-09	15/45					
TE610E 99-07	15/45					
TE449 11-13		-	-	46T	1211-2528¹	■ Aluminum
TC449 11-13				47T	1211-1139	■ Aluminum
TXC449 11-13				48T	1211-1140	■ Aluminum
TE511 11-13				49T	1211-1141	■ Aluminum
				50T	1211-1142	■ Aluminum
				51T	1211-1143	■ Aluminum
				52T	1211-1144	■ Aluminum
KAWASAKI						
KX60 85-04	13/44	12T	R258-420-12	-	-	
		13T	R258-420-13			
		14T	R258-420-14			
KX65 00-01	13/46	12T	R258-420-12	47T	R408U-42047	■ Aluminum
KX65 02-20	13/47	13T	R258-420-13	47T	1211-1683	■ Green
		14T	R258-420-14			■ Aluminum
KX80 86-87, 89-97	13/49	12T	R258-420-12	49T	R191-49	■ Aluminum
KX80 88	13/48	13T	R258-420-13	50T	R191-50	■ Aluminum
KX80 98-99	14/50	14T	R258-420-14	50T	1211-1679	■ Green
KX80 00	14/51			51T	R191-51	■ Aluminum
KX80BW 86-87	13/55			51T	1211-1680	■ Green
KX80BW 91-97	13/54			52T	1211-0094	■ Aluminum
KX80BW 98-02	13/51			53T	1211-2517¹	■ Aluminum
KX85 01-20	14/50					
KX85BW 01-07	13/51					
KX100 87-88	14/53					
KX100 89-90, 96-97	13/52					
KX100 91-95	13/54					
KX100 98-20	13/51					
KLX110 02	14/37	14T	R431-420-14	-	-	
KLX110 03-09	14/33	15T	1212-0128			
KLX110 10-20	14/38					

¹ Ultralight

² Ultralight grooved



SPROCKETS

FITS MODEL	GEARING	FRONT SIZE	PART #	REAR SIZE	PART#	OPTIONAL COLOR				
KAWASAKI (CONT.)										
KX125 85-91	12/47-49	-	-	45T	R112B-45	■ Aluminum				
				47T	1211-2515	■ Black				
				48T	1211-0015	■ Black				
				48T	1211-1345	■ Green				
				49T	1211-0016	■ Black				
				49T	1211-1346	■ Green				
				50T	1211-0017	■ Black				
				50T	1211-1347	■ Green				
				51T	1211-1348	■ Green				
				51T	1211-0018	■ Black				
				51T	1211-1348	■ Green				
				52T	1211-0019	■ Black				
				52T	1211-1674	■ Green				
53T	1211-1675	■ Green								
KX125 92-95	12/49	12T	R337-520-12	45T	R112B-45	■ Aluminum				
KX125 96-97	13/50	13T	R337-520-13	47T	1211-2515	■ Black				
KX125 98-99	12/48			48T	1211-0015	■ Black				
KX125 00-02	13/49			48T	1211-1345	■ Green				
KX125 03-08	13/51			49T	1211-0016	■ Black				
				49T	1211-1346	■ Green				
				50T	1211-0017	■ Black				
				50T	1211-1347	■ Green				
				51T	1211-1348	■ Green				
				51T	1211-0018	■ Black				
				51T	1211-1348	■ Green				
				52T	1211-0019	■ Black				
				52T	1211-1674	■ Green				
				53T	1211-1675	■ Green				
				KLX140 08-17	14/50	13T	1212-0609	50T	1211-0913	■ Aluminum
				KLX140L 08-17	13/51	14T	1212-1607	51T	1211-2526	■ Aluminum
				KDX200 84-88	13/48	12T	R252-520-12	45T	R112B-45	
KDX200 89-06	13/47	13T	R252-520-13	47T	1211-2515	■ Black				
				48T	1211-0015	■ Black				
				48T	1211-1345	■ Green				
				49T	1211-0016	■ Black				
				49T	1211-1346	■ Green				
				50T	1211-0017	■ Black				
				50T	1211-1347	■ Green				
				51T	1211-1348	■ Green				
				51T	1211-0018	■ Black				
				51T	1211-1348	■ Green				
				52T	1211-0019	■ Black				
				52T	1211-1674	■ Green				
				53T	1211-1675	■ Green				
KDX220R 97-05	13/47	15T	R252-520-14	48T	1211-0015	■ Black				
			R252-520-15	48T	1211-1345	■ Green				
				49T	1211-0016	■ Black				
				49T	1211-1346	■ Green				
				50T	1211-0017	■ Black				
KLX250 94-98	14/50	12T	R252-520-12	45T	R112B-45	■ Aluminum				
		13T	R252-520-13	47T	1211-2515	■ Black				
		14T	R252-520-14	48T	1211-0015	■ Black				
		15T	R252-520-15	48T	1211-1345	■ Green				
				49T	1211-0016	■ Black				
				49T	1211-1346	■ Green				
				50T	1211-0017	■ Black				
				50T	1211-1347	■ Green				
				51T	1211-1348	■ Green				
				51T	1211-0018	■ Black				
				51T	1211-1348	■ Green				
				52T	1211-0019	■ Black				
				52T	1211-1674	■ Green				
		53T	1211-1675	■ Green						
KLX250S 06-17	14/42	-	-	45T	R112B-45	■ Aluminum				
				47T	1211-2515	■ Black				
				48T	1211-0015	■ Black				
				48T	1211-1345	■ Green				
				49T	1211-0016	■ Black				
				49T	1211-1346	■ Green				
				50T	1211-0017	■ Black				
				50T	1211-1347	■ Green				
				51T	1211-1348	■ Green				
				51T	1211-0018	■ Black				
				51T	1211-1348	■ Green				
				52T	1211-0019	■ Black				
				52T	1211-1674	■ Green				
53T	1211-1675	■ Green								



FITS MODEL	GEARING	FRONT SIZE	PART #	REAR SIZE	PART#	OPTIONAL COLOR
KAWASAKI (CONT.)						
KX250 85-86	14/50	-	-	45T	R112B-45	■ Aluminum
				47T	1211-2515	■ Black
				48T	1211-0015	■ Black
				48T	1211-1345	■ Green
				49T	1211-0016	■ Black
				49T	1211-1346	■ Green
				50T	1211-0017	■ Black
				50T	1211-1347	■ Green
				51T	1211-1348	■ Green
				51T	1211-0018	■ Black
				51T	1211-1348	■ Green
				52T	1211-0019	■ Black
				52T	1211-1674	■ Green
53T	1211-1675	■ Green				
KX250 87-89	14/47	12T	R252-520-12	45T	R112B-45	■ Aluminum
KX250 90-91	14/48	13T	R252-520-13	47T	1211-2515	■ Black
KX250 92-96	14/49	14T	R252-520-14	48T	1211-0015	■ Black
KX250 97	13/49	15T	R252-520-15	48T	1211-1345	■ Green
KX250 98	13/48			49T	1211-0016	■ Black
KDX250 91-94	14/48			49T	1211-1346	■ Green
				50T	1211-0017	■ Black
				50T	1211-1347	■ Green
				51T	1211-1348	■ Green
				51T	1211-0018	■ Black
				51T	1211-1348	■ Green
				52T	1211-0019	■ Black
				52T	1211-1674	■ Green
53T	1211-1675	■ Green				
KX250 99-01	14/49	12T	R289-520-12	45T	R112B-45	■ Aluminum
KX250 02-04	13/49	13T	R289-520-13	47T	1211-2515	■ Black
KX250 05-08	13/51		1212-1638 ¹	48T	1211-0015	■ Black
				48T	1211-1345	■ Green
			R289-520-14	49T	1211-0016	■ Black
				49T	1211-1346	■ Green
			R289-520-15	50T	1211-0017	■ Black
				50T	1211-1347	■ Green
				51T	1211-1348	■ Green
		51T	1211-0018	■ Black		
		51T	1211-1348	■ Green		
		52T	1211-0019	■ Black		
		52T	1211-1674	■ Green		
		53T	1211-1675	■ Green		
KX250F 04-05	13/48	13T	1212-0022	45T	R112B-45	■ Aluminum
				47T	1211-2515	■ Black
				48T	1211-0015	■ Black
				48T	1211-1345	■ Green
				49T	1211-0016	■ Black
				49T	1211-1346	■ Green
				50T	1211-0017	■ Black
				50T	1211-1347	■ Green
				51T	1211-1348	■ Green
				51T	1211-0018	■ Black
				51T	1211-1348	■ Green
				52T	1211-0019	■ Black
				52T	1211-1674	■ Green
				53T	1211-1675	■ Green
KX250F 06-10	13/48	13T	1212-0203	45T	R112B-45	■ Aluminum
KX250F 11-20	13/50		1212-1631 ¹	47T	1211-2515	■ Black
				48T	1211-0015	■ Black
			1212-0204	48T	1211-1345	■ Green
				48T	1211-1345	■ Green
			1212-1630 ¹	48T	1211-1345	■ Black
				49T	1211-0016	■ Black
				49T	1211-1346	■ Green
				50T	1211-0017	■ Black
				50T	1211-1347	■ Green
				51T	1211-1348	■ Green
				51T	1211-0018	■ Black
		51T	1211-1348	■ Green		
		52T	1211-0019	■ Black		
		52T	1211-1674	■ Green		
		53T	1211-1675	■ Green		

¹ Ultralight

FITS MODEL	GEARING	FRONT SIZE	PART #	REAR SIZE	PART#	OPTIONAL COLOR
KAWASAKI (CONT.)						
KLX300R 97-02	14/50	12T	R252-520-12	45T	R112B-45	■ Aluminum
		13T	R252-520-13	47T	1211-2515	■ Black
		14T	R252-520-14	48T	1211-0015	■ Black
		15T	R252-520-15	48T	1211-1345	■ Green
		49T		49T	1211-0016	■ Black
		49T		49T	1211-1346	■ Green
		50T		50T	1211-0017	■ Black
		50T		50T	1211-1347	■ Green
		51T		51T	1211-1348	■ Green
		51T		51T	1211-0018	■ Black
		51T		51T	1211-1348	■ Green
		52T		52T	1211-0019	■ Black
		52T		52T	1211-1674	■ Green
53T		53T	1211-1675	■ Green		
KLX300R 03-08	14/50	12T	R289-520-12	45T	R112B-45	■ Aluminum
		13T	R289-520-13	47T	1211-2515	■ Black
		13T	1212-1638 ¹	48T	1211-0015	■ Black
		14T	R289-520-14	48T	1211-1345	■ Green
		14T	R289U-520-14 ¹	49T	1211-0016	■ Black
		15T	R289-520-15	49T	1211-1346	■ Green
		50T		50T	1211-0017	■ Black
		50T		50T	1211-1347	■ Green
		51T		51T	1211-1348	■ Green
		51T		51T	1211-0018	■ Black
		51T		51T	1211-1348	■ Green
		52T		52T	1211-0019	■ Black
		52T		52T	1211-1674	■ Green
53T		53T	1211-1675	■ Green		
KLX400B 03	14/47	13T	R255-520-13	47T	R123-47	■ Aluminum
KLX400A 03	15/44	14T	R255-520-14	48T	R123-48	■ Aluminum
		15T	1212-1661	49T	R123-49	■ Aluminum
		50T		50T	R123-50	■ Aluminum
		51T		51T	R123-51	■ Aluminum
KX450F 06	13/48	13T	1212-0207	45T	R112B-45	■ Aluminum
KX450F 07-20	13/50	13T	1212-1603 ¹	47T	1211-2515	■ Black
KLX450R 08-17, 19-20	13/50	14T	1212-0208	48T	1211-0015	■ Black
		14T	1212-1637 ¹	48T	1211-1345	■ Green
KLX450R 18	13/52	49T		49T	1211-0016	■ Black
		49T		49T	1211-1346	■ Green
		50T		50T	1211-0017	■ Black
		50T		50T	1211-1347	■ Green
		51T		51T	1211-1348	■ Green
		51T		51T	1211-0018	■ Black
		51T		51T	1211-1348	■ Green
		52T		52T	1211-0019	■ Black
		52T		52T	1211-1674	■ Green
		53T		53T	1211-1675	■ Green
		KX500 87-04	14/47	12T	R252-520-12	45T
13T	R252-520-13			47T	1211-2515	■ Black
14T	R252-520-14			48T	1211-0015	■ Black
15T	R252-520-15			48T	1211-1345	■ Green
49T				49T	1211-0016	■ Black
49T				49T	1211-1346	■ Green
50T				50T	1211-0017	■ Black
50T				50T	1211-1347	■ Green
51T				51T	1211-1348	■ Green
51T				51T	1211-0018	■ Black
51T				51T	1211-1348	■ Green
52T				52T	1211-0019	■ Black
52T				52T	1211-1674	■ Green
53T		53T	1211-1675	■ Green		

¹ Ultralight



FITS MODEL	GEARING	FRONT SIZE	PART #	REAR SIZE	PART#	OPTIONAL COLOR				
KAWASAKI (CONT.)										
KLX650A 93-96	14/43	-	-	45T	R112B-45	Aluminum				
				47T	1211-2515	Black				
				48T	1211-0015	Black				
				48T	1211-1345	Green				
				49T	1211-0016	Black				
				49T	1211-1346	Green				
				50T	1211-0017	Black				
				50T	1211-1347	Green				
				51T	1211-1348	Green				
				51T	1211-0018	Black				
				51T	1211-1348	Green				
				52T	1211-0019	Black				
				52T	1211-1674	Green				
53T	1211-1675	Green								
KTM										
50 SX 09-10	10/42	10T	1212-0825	39T	1211-1202	Orange				
50 SX 11-12	11/42	11T	1212-0826	40T	1211-1203	Orange				
50 SX 13	11/40	12T	1212-0827	42T	1211-1205	Orange				
50 SX 14-20	11/40	10T	1212-0825	36T	1211-1208	Black				
		11T	1212-0826	36T	1211-2489	Orange				
		12T	1212-0827	38T	1211-1209	Black				
		38T	1211-2490	Orange						
		40T	1211-1210	Black						
40T	1211-2491	Orange								
60/65 SX 98-02	13/46	13T	1212-1659	46T	R192U-42046	Aluminum				
65 SX 03	12/50	14T	1212-0044	46T	1211-2465	Orange				
65 SX 04-08	14/50			48T	R192U-42048	Aluminum				
				48T	1211-2467	Orange				
				50T	1211-0087	Aluminum				
				50T	1211-2468	Orange				
65 SX 09-12	14/50	13T	1212-1584	46T	R192U-42046	Aluminum				
65 SX 13-20	14/48			46T	1211-2465	Orange				
				48T	R192U-42048	Aluminum				
				48T	1211-2467	Orange				
				50T	1211-0087	Aluminum				
				50T	1211-2468	Orange				
85 SX 04-09	14/46	13T	1212-1585	46T	1211-0088	Aluminum				
85 SX (LW) 04-09	14/49	14T	1212-0828	46T	1211-1722	Blue				
105 SX 04-09	14/49			47T	1211-0089	Aluminum				
				47T	1211-1723	Blue				
				48T	1211-0090	Aluminum				
				48T	1211-1724	Blue				
				49T	1211-0091	Aluminum				
				49T	1211-1725	Blue				
				50T	1211-0092	Aluminum				
				50T	1211-1726	Blue				
				85 SX 10-11	14/46	13T	1212-1585	46T	1211-0088	Aluminum
				85 SX 12-17	14/49	14T	1212-0828	46T	1211-1722	Blue
105 SX 10-11	14/49			47T	1211-0089	Aluminum				
				47T	1211-1723	Blue				
				48T	1211-0090	Aluminum				
				48T	1211-1724	Blue				
				49T	1211-0091	Aluminum				
				49T	1211-1725	Blue				
				50T	1211-0092	Aluminum				
				50T	1211-1726	Blue				
				85 SX 18-20	13/49	13T	1212-1458	46T	1211-0088	Aluminum
						14T	1212-1459	46T	1211-1722	Blue
47T	1211-0089	Aluminum								
47T	1211-1723	Blue								
48T	1211-0090	Aluminum								
48T	1211-1724	Blue								
49T	1211-0091	Aluminum								
49T	1211-1725	Blue								
50T	1211-0092	Aluminum								
50T	1211-1726	Blue								



SPROCKETS

FITS MODEL	GEARING	FRONT SIZE	PART #	REAR SIZE	PART#	OPTIONAL COLOR
KTM (CONT.)						
125 MX 88-89	13/50	11T	1212-1300	-	-	
125 MX 90	13/52	12T	1212-1660			
125 Enduro 86-90	13/50	13T	R292-520-13			
		13T	1212-0884 ¹			
		14T	R292-520-14			
		14T	1212-0885 ¹			
		15T	1212-0046			
125 MX 91-93	13/52	11T	1212-1300	45T	1211-0078	Aluminum
125 SX 91-20	13/50	12T	1212-1660	45T	1211-2471	Orange
125 EXC/MXC 91-98	13/48	13T	R292-520-13	46T	1211-0079	Aluminum
125 EXC/MXC 99-05	13/50	13T	1212-0884 ¹	46T	1211-2472	Orange
150 EXC TPI 20	13/50	14T	R292-520-14	47T	1211-2473	Orange
150 SX 09-19	14/50	14T	1212-0885 ¹	48T	R224-48	Aluminum
200 EXC/MXC 98-05	14/48	15T	1212-0046	48T	1211-0045	Black
200 SX 03-05	14/45			48T	1211-2474	Orange
200 XC/XC-W 07-15	14/48			48T	1211-1343	Blue
250 EXC/MXC 98-01	14/50			49T	1211-0046	Black
250 XC/XC-W 07-19	13/50			49T	1211-2475	Orange
				49T	1211-1332	Blue
				50T	R224-50	Aluminum
				50T	1211-0047	Black
				50T	1211-2476	Orange
				50T	1211-1333	Blue
				51T	R224-51	Aluminum
				51T	1211-0048	Black
				51T	1211-2477	Orange
				51T	1211-1334	Blue
		52T	R224-52	Aluminum		
		52T	1211-0049	Black		
		52T	1211-2478	Orange		
		53T	1211-0104	Aluminum		
		53T	1211-2479	Orange		
250 MX 90-94	13/50	11T	1212-1300	45T	1211-0078	Aluminum
250 DXC 92-94	15/50	12T	1212-1660	45T	1211-2471	Orange
250 MX/Enduro 90-92	14/50	13T	R292-520-13	46T	1211-0079	Aluminum
250 EXC 91-99	14/50	13T	1212-0884 ¹	46T	1211-2472	Orange
250 EXC 00-06	14/52	14T	R292-520-14	47T	1211-2473	Orange
250 SX 91-03	14/50	14T	1212-0885 ¹	48T	R224-48	Aluminum
250 SX 04-20	13/48	15T	1212-0046	48T	1211-0045	Black
250 SX-F 06-15	13/48			48T	1211-2474	Orange
250 SX-F 16-18	14/51			48T	1211-1343	Blue
250 XCF/XCF-W 07-15	13/52			49T	1211-0046	Black
250 SX-F 19-20	14/52			49T	1211-2475	Orange
				49T	1211-1332	Blue
				50T	R224-50	Aluminum
				50T	1211-0047	Black
				50T	1211-2476	Orange
				50T	1211-1333	Blue
				51T	R224-51	Aluminum
				51T	1211-0048	Black
				51T	1211-2477	Orange
				51T	1211-1334	Blue
		52T	R224-52	Aluminum		
		52T	1211-0049	Black		
		52T	1211-2478	Orange		
		53T	1211-0104	Aluminum		
		53T	1211-2479	Orange		
300 90-94 (all)	14/48	11T	1212-1300	45T	1211-0078	Aluminum
300 SX 95	13/50	12T	1212-1660	45T	1211-2471	Orange
300 MXC/EXC 96-04	14/52	13T	R292-520-13	46T	1211-0079	Aluminum
300 EXC 05-06	13/50	13T	1212-0884 ¹	46T	1211-2472	Orange
300 XC 07-18	13/50	14T	R292-520-14	47T	1211-2473	Orange
300 XC-W 07-20	13/48	14T	1212-0885 ¹	48T	R224-48	Aluminum
		15T	1212-0046	48T	1211-0045	Black

¹ Ultralight



FITS MODEL	GEARING	FRONT SIZE	PART #	REAR SIZE	PART#	OPTIONAL COLOR
KTM (CONT.)						
				48T	1211-2474	Orange
				48T	1211-1343	Blue
				49T	1211-0046	Black
				49T	1211-2475	Orange
				49T	1211-1332	Blue
				50T	R224-50	Aluminum
				50T	1211-0047	Black
				50T	1211-2476	Orange
				50T	1211-1333	Blue
				51T	R224-51	Aluminum
				51T	1211-0048	Black
				51T	1211-2477	Orange
				51T	1211-1334	Blue
				52T	R224-52	Aluminum
				52T	1211-0049	Black
				52T	1211-2478	Orange
				53T	1211-0104	Aluminum
				53T	1211-2479	Orange
350 SX-F 11-20	14/50	11T	1212-1300	45T	1211-0078	Aluminum
350 XC-F 11-20	14/50	12T	1212-1660	45T	1211-2471	Orange
350 EXC-F 12-20	14/45	13T	R292-520-13	46T	1211-0079	Aluminum
		13T	1212-0884 ¹	46T	1211-2472	Orange
		14T	R292-520-14	47T	1211-2473	Orange
		14T	1212-0885 ¹	48T	R224-48	Aluminum
		15T	1212-0046	48T	1211-0045	Black
				48T	1211-2474	Orange
				48T	1211-1343	Blue
				49T	1211-0046	Black
				49T	1211-2475	Orange
				49T	1211-1332	Blue
				50T	R224-50	Aluminum
				50T	1211-0047	Black
				50T	1211-2476	Orange
				50T	1211-1333	Blue
				51T	R224-51	Aluminum
				51T	1211-0048	Black
				51T	1211-2477	Orange
				51T	1211-1334	Blue
				52T	R224-52	Aluminum
				52T	1211-0049	Black
				52T	1211-2478	Orange
				53T	1211-0104	Aluminum
				53T	1211-2479	Orange
400 LC4 95-96				45T	1211-0078	Aluminum
400 LC4 97-00				45T	1211-2471	Orange
				46T	1211-0079	Aluminum
				46T	1211-2472	Orange
				47T	1211-2473	Orange
				48T	R224-48	Aluminum
				48T	1211-0045	Black
				48T	1211-2474	Orange
				48T	1211-1343	Blue
				49T	1211-0046	Black
				49T	1211-2475	Orange
				49T	1211-1332	Blue
				50T	R224-50	Aluminum
				50T	1211-0047	Black
				50T	1211-2476	Orange
				50T	1211-1333	Blue
				51T	R224-51	Aluminum
				51T	1211-0048	Black
				51T	1211-2477	Orange
				51T	1211-1334	Blue
				52T	R224-52	Aluminum
				52T	1211-0049	Black
				52T	1211-2478	Orange
				53T	1211-0104	Aluminum
				53T	1211-2479	Orange

¹ Ultralight



SPROCKETS

FITS MODEL	GEARING	FRONT SIZE	PART #	REAR SIZE	PART#	OPTIONAL COLOR
KTM (CONT.)						
400 SX/EXC 99-07	14/50	11T	1212-1300	45T	1211-0078	■ Aluminum
400 XC-W 09	14/50	12T	1212-1660	45T	1211-2471	■ Orange
440 E/XC 94-95	14/48	13T	R292-520-13	46T	1211-0079	■ Aluminum
450 SX/EXC 03	14/51	13T	1212-0884 ¹	46T	1211-2472	■ Orange
450 SX 04-06	14/53	14T	R292-520-14	47T	1211-2473	■ Orange
450 SX-F 04-20	14/52	14T	1212-0885 ¹	48T	R224-48	■ Aluminum
450 EXC 04-07	14/50	15T	1212-0046	48T	1211-0045	■ Black
450 EXC-R 08-13	15/45			48T	1211-2474	■ Orange
450 XC-F 07-16	14/52			48T	1211-1343	■ Blue
450 XC-W 07-11	14/50			49T	1211-0046	■ Black
450 XC-W 12-16	13/52			49T	1211-2475	■ Orange
500 EXC/XC-W 12-16	15/45			49T	1211-1332	■ Blue
				50T	R224-50	■ Black
				50T	1211-0047	■ Aluminum
				50T	1211-2476	■ Orange
				50T	1211-1333	■ Blue
				51T	R224-51	■ Black
				51T	1211-0048	■ Aluminum
				51T	1211-2477	■ Orange
				51T	1211-1334	■ Blue
				52T	R224-52	■ Black
				52T	1211-0049	■ Aluminum
				52T	1211-2478	■ Orange
				53T	1211-0104	■ Aluminum
				53T	1211-2479	■ Orange
505 SX-F 08-09	14/50	11T	1212-1300	45T	1211-0078	■ Aluminum
505 XC-F 08-09	14/52	12T	1212-1660	45T	1211-2471	■ Orange
505 XC-W 08-09	14/50	13T	R292-520-13	46T	1211-0079	■ Aluminum
520 SX 99-02	14/48	13T	1212-0884 ¹	46T	1211-2472	■ Orange
520 EXC 99	14/50	14T	R292-520-14	47T	1211-2473	■ Orange
520 EXC 00-02	14/48	14T	1212-0885 ¹	48T	R224-48	■ Aluminum
525 EXC 03-06	15/45	15T	1212-0046	48T	1211-0045	■ Black
525 EXC 07	14/48			48T	1211-2474	■ Orange
525 SX 03-06	14/48			48T	1211-1343	■ Blue
530 EXC-R 08-13	15/45			49T	1211-0046	■ Black
				49T	1211-2475	■ Orange
				49T	1211-1332	■ Blue
				50T	R224-50	■ Black
				50T	1211-0047	■ Aluminum
				50T	1211-2476	■ Orange
				50T	1211-1333	■ Blue
				51T	R224-51	■ Black
				51T	1211-0048	■ Aluminum
				51T	1211-2477	■ Orange
				51T	1211-1334	■ Blue
				52T	R224-52	■ Black
				52T	1211-0049	■ Aluminum
				52T	1211-2478	■ Orange
				53T	1211-0104	■ Aluminum
				53T	1211-2479	■ Orange
600LC4/MX 90-94				45T	1211-0078	■ Aluminum
600/620 LC4 90-99 (all)				45T	1211-2471	■ Orange
625 SXC 03-06				46T	1211-0079	■ Aluminum
640/660 99-06 (all)				46T	1211-2472	■ Orange
				47T	1211-2473	■ Orange
				48T	R224-48	■ Aluminum
				48T	1211-0045	■ Black
				48T	1211-2474	■ Orange
				48T	1211-1343	■ Blue
				49T	1211-0046	■ Black
				49T	1211-2475	■ Orange
				49T	1211-1332	■ Blue
				50T	R224-50	■ Aluminum
				50T	1211-0047	■ Black
				50T	1211-2476	■ Orange
				50T	1211-1333	■ Blue
				51T	R224-51	■ Aluminum
				51T	1211-0048	■ Black
				51T	1211-2477	■ Orange
				51T	1211-1334	■ Blue

¹ Ultralight



FITS MODEL	GEARING	FRONT SIZE	PART #	REAR SIZE	PART#	OPTIONAL COLOR
KTM (CONT.)						
				52T	R224-52	■ Aluminum
				52T	1211-0049	■ Black
				52T	1211-2478	■ Orange
				53T	1211-0104	■ Aluminum
				53T	1211-2479	■ Orange
MONTESA						
COTA 4rt 05-12	10/41	10T	1212-1650	41T	1211-2518 ¹	■ Aluminum
				42T	1211-2523 ¹	■ Aluminum
SHERCO						
250 Trials 2.5 02-12	-	-	-	41T	1211-2518 ¹	■ Aluminum
290 Trials 2.9 02-12				42T	1211-2523 ¹	■ Aluminum
320 Trials 3.2 05-11						
SE250 08-16	-	-	-	46T	1211-2528 ¹	■ Aluminum
SE300 10-16				47T	1211-1139	■ Aluminum
SE450 04-11				48T	1211-1140	■ Aluminum
SE510 06-11				49T	1211-1141	■ Aluminum
				50T	1211-1142	■ Aluminum
				51T	1211-1143	■ Aluminum
				52T	1211-1144	■ Aluminum
SUZUKI						
RM60 03-04	13/44	12T	R258-420-12	-	-	
		13T	R258-420-13			
		14T	R258-420-14			
RM65 03-05	13/47	12T	R258-420-12	47T	R408U-42047	
		13T	R258-420-13			
		14T	R258-420-14			
RM80 89-01	14/48	13T	R258-428-13	47T	1211-0281	■ Black
RM85 02-20	14/47	14T	R258-428-14	47T	1211-0285	■ Blue
RM85BW 02-03	14/47			48T	1211-0282	■ Black
RM85BW 04-16	13/47			48T	1211-0286	■ Blue
				49T	1211-0283	■ Black
				49T	1211-0287	■ Blue
				50T	1211-0284	■ Black
				50T	1211-0288	■ Blue
				51T	1211-2524 ¹	■ Aluminum
				52T	1211-2525 ¹	■ Aluminum
DR-Z110 03-05	14/37	14T	R431-420-14	-	-	
		15T	1212-0128			
RM125 80-84	12/51	12T	R254-520-12	41T	1211-2508 ¹	■ Aluminum
RM125 85	12/49	13T	R254-520-13	44T	1211-2521 ¹	■ Aluminum
RM125 86-87	12/51	13T	1212-1602 ¹	47T	R123-47	■ Aluminum
RM125 87-91	13/51			48T	R123-48	■ Aluminum
RM125 92-96	12/49			49T	R123-49	■ Black
RM125 97-99	12/50			50T	R123-50	■ Aluminum
RM125 00-03	12/49			51T	R123-51	■ Black
RM125 04-05	12/50					
RM125 06-07	12/51					
RM250 84-86	14/50	13T	R255-520-13	-	-	
DR250SE 93-95	14/42	14T	R255-520-14			
		15T	1212-1661			
RM250 89-97	13/49	13T	R255-520-13	41T	1211-2508 ¹	■ Aluminum
RM250 98-99	13/50	14T	R255-520-14	44T	1211-2521 ¹	■ Aluminum
RM250 00	13/48	15T	1212-1661	47T	R123-47	■ Aluminum
RM250 01-03	13/49			48T	R123-48	■ Aluminum
RM250 04-06	13/48			49T	R123-49	■ Black
RM250 07-08	13/50			50T	R123-50	■ Aluminum
RMX250 89-99	13/49			51T	R123-51	■ Black
RMZ250 04-06	13/48	13T	1212-0022	45T	R112B-45	
				48T	1211-0015	■ Black
				49T	1211-0016	■ Black
				50T	1211-0017	■ Black
				51T	1211-0018	■ Black
				52T	1211-0019	■ Black
RMZ250 07-09	12/48	12T	R254-520-12	41T	1211-2508 ¹	■ Aluminum
RMZ250 10-12	13/49	13T	R254-520-13	44T	1211-2521 ¹	■ Aluminum
		13T	1212-1602 ¹	47T	R123-47	■ Aluminum
				48T	R123-48	■ Aluminum
				49T	R123-49	■ Black
				50T	R123-50	■ Aluminum
				51T	R123-51	■ Black

¹ Ultralight

FITS MODEL	GEARING	FRONT SIZE	PART #	REAR SIZE	PART#	OPTIONAL COLOR
SUZUKI (CONT.)						
RMZ250 13-17	13/49	13T GP	1212-1298	41T	1211-2508 ¹	Aluminum
		13T GP	1212-1299 ¹	44T	1211-2521 ¹	Aluminum
				47T	R123-47	Aluminum
				48T	R123-48	Aluminum
				49T	R123-49	Black
				50T	R123-50	Aluminum
				51T	R123-51	Black
DR350 90-96	14/47	13T	R255-520-13	41T	1211-2508 ¹	Aluminum
DR350SE 96-97	15/41	14T	R255-520-14	44T	1211-2521 ¹	Aluminum
DR350 98	15/43	15T	1212-1661	47T	R123-47	Aluminum
				48T	R123-48	Aluminum
				49T	R123-49	Black
				50T	R123-50	Aluminum
				51T	R123-51	Black
DR350S 90-95	14/43	13T	R255-520-13	-	-	
		14T	R255-520-14			
		15T	1212-1661			
DR-Z400/E 00-08	14/47	13T	R255-520-13	41T	1211-2508 ¹	Aluminum
DR-Z400S 00-17	15/44	14T	R255-520-14	44T	1211-2521 ¹	Aluminum
DR-Z400SM 05-17	15/41	15T	1212-1661	47T	R123-47	Aluminum
				48T	R123-48	Aluminum
				49T	R123-49	Black
				50T	R123-50	Aluminum
				51T	R123-51	Black
RMZ450 05	14/49	13T	1212-0088	41T	1211-2508 ¹	Aluminum
RMZ450 06	14/48	13T	1212-1671	44T	1211-2521 ¹	Aluminum
RMZ450 07	14/49	13T	1212-1632 ¹	47T	R123-47	Aluminum
RMZ450 08-12	13/50	14T	1212-1657	48T	R123-48	Aluminum
				49T	R123-49	Black
				50T	R123-50	Aluminum
				51T	R123-51	Black
RMZ450 13-19	13/50	13T	1212-1212 ¹	41T	1211-2508 ¹	Aluminum
		13T	1212-1228	44T	1211-2521 ¹	Aluminum
		14T	1212-1213 ¹	47T	R123-47	Aluminum
		14T	1212-1229	48T	R123-48	Aluminum
				49T	R123-49	Black
				50T	R123-50	Aluminum
		51T	R123-51	Black		
TM						
125MX 03-13	-	-	-	51T	1211-2516	Aluminum
EN 125 Enduro 01-15						
EN 144 07-13						
MX 144 08-13						
MX 250F 02-09						
EN 250 Enduro 99-13						
EN 250 F Enduro 02-10						
MX250 01-13						
EN 300 Enduro 01-13						
MX 300 01-13						
EN 450F 03-15						
MX 450F 03-13						
MX 530F 04-13						
EN250 Fi Enduro 11-13	13/51	12T	1212-0727	51T	1211-2516	Aluminum
MX250 Fi 11-13	13/51	13T	1212-0728			
YAMAHA						
YZ65 18-20	14/47	14T	1212-1460	-	-	
YZ80 86-92	15/46	13T	R258-428-13	-	-	
		14T	R258-428-14			
YZ80 93-01	14/47	14T	R258-428-14	47T	1211-0281	Black
				47T	1211-0285	Blue
				48T	1211-0282	Black
				48T	1211-0286	Blue
				49T	1211-0283	Black
				49T	1211-0287	Blue
				50T	1211-0284	Black
				50T	1211-0288	Blue
				51T	1211-2524 ¹	Aluminum
				52T	1211-2525 ¹	Aluminum

¹ Ultralight



FITS MODEL	GEARING	FRONT SIZE	PART #	REAR SIZE	PART#	OPTIONAL COLOR
YAMAHA (CONT.)						
YZ85 02	14/48	13T	R257-428-13	47T	1211-0281	■ Black
YZ85 03-18	14/47	14T	R257-428-14	47T	1211-0285	■ Blue
YZ85 19-20	14/46			48T	1211-0282	■ Black
				48T	1211-0286	■ Blue
				49T	1211-0283	■ Black
				49T	1211-0287	■ Blue
				50T	1211-0284	■ Black
				50T	1211-0288	■ Blue
				51T	1211-2524 ¹	■ Aluminum
				52T	1211-2525 ¹	■ Aluminum
WR125X/R 09-16	14/53	14T	1212-1590	53T	1110-0083	■ Aluminum
YZ125 80	12/48	-	-			
YZ125 81-82	12/49					
YZ125 83	12/48					
YZ125 84-85	12/50					
YZ125 86	13/50					
YZ125 89-92	13/50	13T	R257-520-13			■ Aluminum
YZ125 93-96	13/50	14T	1212-1663			■ Aluminum
YZ125 97-98	13/48					
YZ125 99-01	13/48	13T	R257-520-13	46T	R150A-520-46	■ Aluminum
YZ125 02-04	13/49	14T	1212-1663	48T	R150A-520-48	■ Aluminum
				48T	1211-0025	■ Black
				48T	1211-0164	■ Blue
				49T	R150A-520-49	■ Aluminum
				49T	1211-0026	■ Black
				49T	1211-0165	■ Blue
				50T	R150A-520-50	■ Aluminum
				50T	1211-0027	■ Black
				50T	1211-0166	■ Blue
				51T	1211-0028	■ Black
				51T	1211-0167	■ Blue
YZ125 05-20	13/48	13T	1212-0991	46T	R150A-520-46	■ Aluminum
		14T	1212-0992	48T	R150A-520-48	■ Aluminum
				48T	1211-0025	■ Black
				48T	1211-0164	■ Blue
				49T	R150A-520-49	■ Aluminum
				49T	1211-0026	■ Black
				49T	1211-0165	■ Blue
				50T	R150A-520-50	■ Aluminum
				50T	1211-0027	■ Black
				50T	1211-0166	■ Blue
				51T	1211-0028	■ Black
				51T	1211-0167	■ Blue
WR200 91-92	13/52	13T	R257-520-13	-	-	
		14T	1212-1663			
TTR 230 05-08		13T	R366-520-13	-	-	
		14T	R366-520-14			
YZ250 88-93	14/49	12T	R252-520-12	-	-	
YZ250 94-97	13/49	13T	R252-520-13			
YZ250 98	14/49	14T	R252-520-14			
YZ250WR 89	14/49	15T	R252-520-15			
YZ250WR 90	14/51					
WR250 91-92, 94-96	14/52					
WR250 93	14/51					
WR250 97	13/48					
YZ250 99-01	14/50	12T	R289-520-12	46T	R150A-520-46	■ Aluminum
YZ250 02-04	14/49	13T	R289-520-13	48T	R150A-520-48	■ Aluminum
YZ250 05-20	14/50	13T	1212-1638 ¹	48T	1211-0025	■ Black
		14T	R289-520-14	48T	1211-0164	■ Blue
		14T	R289U-520-14 ¹	49T	R150A-520-49	■ Aluminum
		15T	R289-520-15	49T	1211-0026	■ Black
				49T	1211-0165	■ Blue
				50T	R150A-520-50	■ Aluminum
				50T	1211-0027	■ Black
				50T	1211-0166	■ Blue
				51T	1211-0028	■ Black
				51T	1211-0167	■ Blue

¹ Ultralight



SPROCKETS

FITS MODEL	GEARING	FRONT SIZE	PART #	REAR SIZE	PART#	OPTIONAL COLOR
YAMAHA (CONT.)						
YZ250F 01-04	13/48	13T	1212-0991	46T	R150A-520-46	■ Aluminum
YZ250F 05-11	13/49	14T	1212-0992	48T	R150A-520-48	■ Aluminum
YZ250F 12-20	13/50			48T	1211-0025	■ Black
WR250F 01-07	13/52			48T	1211-0164	■ Blue
WR250F 08-18	13/50			49T	R150A-520-49	■ Aluminum
				49T	1211-0026	■ Black
				49T	1211-0165	■ Blue
				50T	R150A-520-50	■ Aluminum
				50T	1211-0027	■ Black
				50T	1211-0166	■ Blue
				51T	1211-0028	■ Black
				51T	1211-0167	■ Blue
YZ400F 98	14/49	12T	R289-520-12	-	-	
WR400F 98		13T	R289-520-13			
		13T	1212-1638 ¹			
		14T	R289-520-14			
		14T	R289U-520-14 ¹			
		15T	R289-520-15			
YZ400F 99	14/49	12T	R289-520-12	46T	R150A-520-46	■ Aluminum
WR400F 99-00	14/50	13T	R289-520-13	48T	R150A-520-48	■ Aluminum
YZ426F 00-02	14/48	13T	1212-1638 ¹	48T	1211-0025	■ Black
WR426F 01-02	14/50	14T	R289-520-14	48T	1211-0164	■ Blue
YZ450F 03-04	14/48	14T	R289U-520-14 ¹	49T	R150A-520-49	■ Aluminum
YZ450F 05	14/51	15T	R289-520-15	49T	1211-0026	■ Black
YZ450F 06-09	13/49			49T	1211-0165	■ Blue
YZ450F 10-13, 15-20	13/48			50T	R150A-520-50	■ Aluminum
YZ450F 14	13/49			50T	1211-0027	■ Black
WR450F 03-06	14/50			50T	1211-0166	■ Blue
WR450F 07-14	13/48			51T	1211-0028	■ Black
				51T	1211-0167	■ Blue
YZ490 82	14/44	12T	R252-520-12	-	-	
YZ490 83-84	14/46	13T	R252-520-13			
YZ490 85	14/44	14T	R252-520-14			
YZ490 86-90	14/48	15T	R252-520-15			
WR500 92-93	15/50	12T	R252-520-12	-	-	
		13T	R252-520-13			
		14T	R252-520-14			
		15T	R252-520-15			

¹ Ultraight

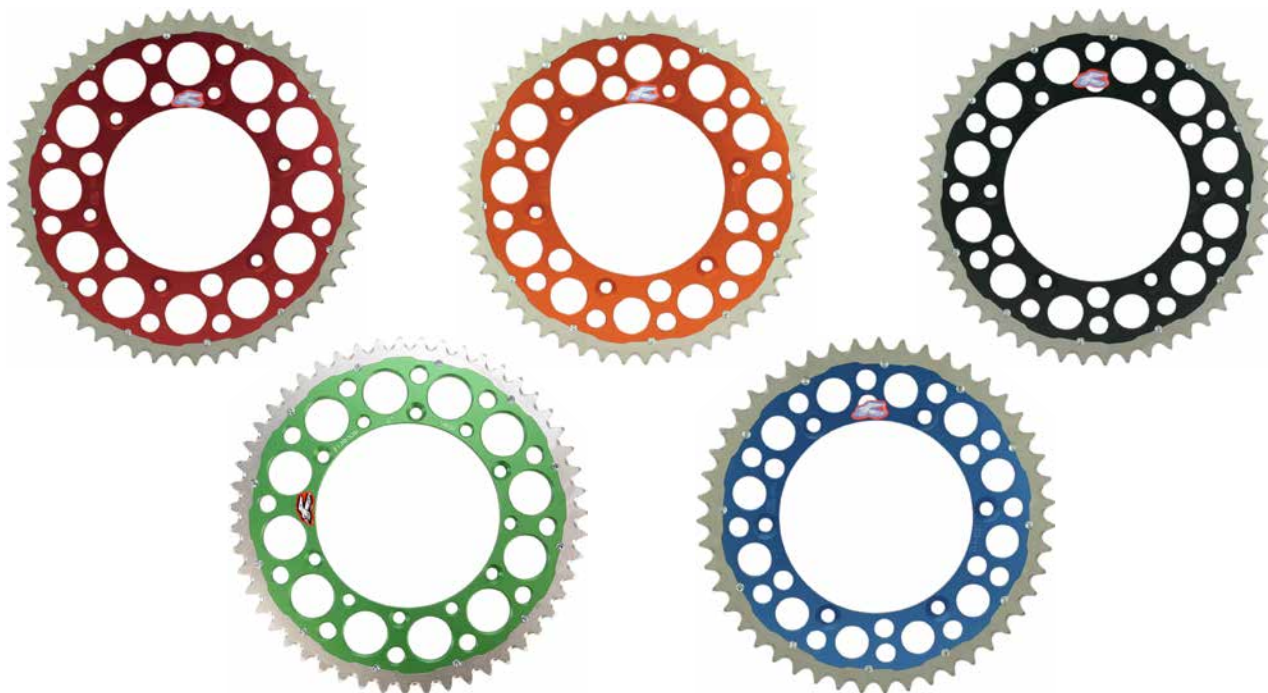

TWINRING™ REAR SPROCKETS

- Inner ring is the same high strength Ultralight™ 7075-T6 aluminum used for the standard Renthal sprocket
- Outer ring is electroless nickel coated steel for ultimate durability and designed with the minimum amount of material to keep weight down
- The outer ring is expanded at 200°C and then fitted over the inner; this interference fit combined with the wave pattern ensures a permanent bond for the life of the chainwheel
- Flat socket setscrews add additional strength to the chainwheel during side impacts and eliminates contact with the chain guide
- Self-cleaning mud grooves between each tooth prevent mud buildup and reduce chainwheel wear and weight
- Will outlast a standard all-aluminum sprocket by three times, yet is much lighter than an all steel rear sprocket

FITS MODEL	SIZE	PART #	OPTIONAL COLOR
HONDA			
CR125R 87-07, CRF150F 03-17, CRF230F 03-17, CR250R 84-08, CRF250R 04-20, CRF250X 12-16, XR250R 88-05, XR400R 96-04, CRF450R/X 02-20, CR500R 86-01, XR650R 00-07	48T	1210-0811	■ Black
	48T	1210-0820	■ Red
	49T	1210-0812	■ Black
	49T	1210-0821	■ Red
	50T	1210-0813	■ Black
	50T	1210-0822	■ Red
	51T	1210-0814	■ Black
	51T	1210-0823	■ Red
HUSABERG			
TE125 13-14, FE250 13-14, TE250/300 12-14, FE350 13-14, FE390 10-12, FE/FS450E 06-07, FX450 10-12, FE450E 09-13, FE501 13-15, FE550 05-08, FC550 05-08, FS570 10-11, FE570 09-12, FS650C 06-07, FE650E 06-07, FS650E 03-08	48T	1210-0815	■ Black
	48T	1210-0983	■ Orange
	48T	1210-1136	■ Blue
	50T	1210-0816	■ Black
	50T	1210-0984	■ Orange
	50T	1210-1137	■ Blue
	52T	1210-0817	■ Black
	52T	1210-0985	■ Orange
	52T	1210-1138	■ Blue
HUSQVARNA			
All 125 thru 530 14-20, 701 Enduro 17-19, 701 Supertmoto 17-19	48T	1210-0815	■ Black
	48T	1210-0983	■ Orange
	48T	1210-1136	■ Blue
	50T	1210-0816	■ Black
	50T	1210-0984	■ Orange
	50T	1210-1137	■ Blue
	52T	1210-0817	■ Black
	52T	1210-0985	■ Orange
	52T	1210-1138	■ Blue

FITS MODEL	SIZE	PART #	OPTIONAL COLOR
KAWASAKI			
KX125 85-08, KDX200 84-94, KDX220R 97-06, KLX250R 94-96, KLX250S 06-17, KX250 87-08, KDX250 91-94, KX250F 04-20, KLX300R 97-07/20, KLX450F 17, KX450F 06-20, KLX450R 09-20, KX500 87-04, KLX650A93-96, KLX650R 93-96	50T	1210-0805	■ Black
	50T	1210-1140	■ Green
	51T	1210-0806	■ Black
	51T	1210-1141	■ Green
KLX400A/B 03-04	49T	1210-0807	■ Black
	50T	1210-0808	■ Black
KTM			
All 125 thru 530 91-20, 620 Adventurer/ Duke/ LC4/E 97-99, 625SXC 03-06, 640 Adventurer/ Duke/ LC4 99-06, 660 Rally/ SMC 02-06, 690 Duke/R 08-17, 690 Enduro R 10-19, 690 SMC/R 08-17, 690 Supertmoto 07-08, 790 Duke 19	48T	1210-0815	■ Black
	48T	1210-0983	■ Orange
	48T	1210-1136	■ Blue
	50T	1210-0816	■ Black
	50T	1210-0984	■ Orange
	50T	1210-1137	■ Blue
	52T	1210-0817	■ Black
	52T	1210-0985	■ Orange
	52T	1210-1138	■ Blue
SUZUKI			
RM125 88-11, DR-Z 250 04-07, RM250 89-11, RMX250 89-01, RM-Z250 04-20, DR350 91-93/96-99, DR-Z400E/SM 00-11, RMX450Z 10-19, RM-Z450 05-20	49T	1210-0807	■ Black
	50T	1210-0808	■ Black
RM-Z250 04-06	50T	1210-0805	■ Black
	50T	1210-1140	■ Green
	51T	1210-0806	■ Black
	51T	1210-1141	■ Green
YAMAHA			
YZ125/250 99-20, WR250F 01-20, YZ250F/FX/G 01-20, YZ400F 99, WR400F 99-00, WR/YZ426F 00-02, WR450F 03-18, YZ450F/FX 03-20	48T	1210-1344	■ Black
	48T	1210-1343	■ Blue
	49T	1210-0809	■ Black
	49T	1210-0818	■ Blue
	50T	1210-0810	■ Black
	50T	1210-0819	■ Blue



415 R1 WORKS CHAIN

- Premium high-strength chain; impact load resistance
- Steel plates shot-peened for high strength and maximum resistance
- Chamfered inner links reduce derailment
- Pre-formed bushings distribute load for longer chain life
- Recommended for MX 2-strokes up to 70cc, MX 4-strokes up to 100cc and trials bikes up to 125cc
- Includes masterlink and pair of latex gloves



DESCRIPTION	PART #	DESCRIPTION	PART #
112 links	1220-0413	Repl. clip connecting link	1225-0550

420 R1 WORKS CHAIN

- A mini version of Renthal's 520 R1 chain for today's high-powered mini racing machines
- Shot-peened alloy steel side plates
- Ultra-high 2091 kg (4609 lb) average tensile strength
- Chromised bearing pins resist wear
- Pre-formed bushings distribute power loads evenly for greater chain life
- Gold-colored side plates; copper-colored rollers
- The perfect match for Renthal sprockets
- Clip type link included



DESCRIPTION	PART #	DESCRIPTION	PART #	DESCRIPTION	PART #
120 links	R1-420-120	130 links	R1-420-130	Repl. clip connecting link	R1-420-ML

428 R1 WORKS CHAIN

- Designed for high-powered mini racing machines up to 100cc capacity that use 428 non-O-ring chain
- Shot-peened alloy steel side plates
- Extended bushings to reduce friction between outer and inner link plates, which maximizes power transmission
- Ultra-high 2039 kg (4496 lb) average tensile strength
- Case-hardened alloy steel bearing pins for maximum resistance to wear
- Gold-colored side plates help reduce corrosion
- The perfect match for Renthal sprockets
- Clip type link included



DESCRIPTION	PART #	DESCRIPTION	PART #
120 links	R1-428-120	140 links	1221-0017
130 links	R1-428-130	Repl. clip connecting link	R1-428-ML
134 links	1221-0302		

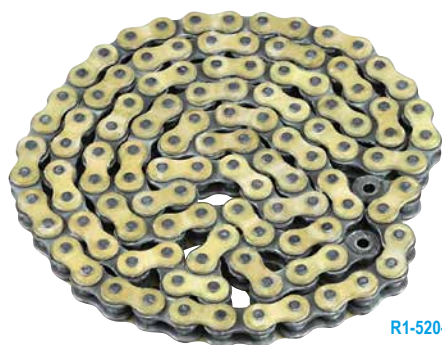

R1-520-116



R1-520-ML



R1-520-120

520 R1 WORKS CHAIN

- Premium-quality, high-strength, lightweight non-O-ring chain
- Specifically designed for racing
- The choice when high strength, light weight and maximum power transfer are essential
- Shot-peened alloy steel side plates
- Ultra-high 3467 kg (7644 lb) average tensile strength
- Chamfered inner links reduce the chance of chain derailment
- Chromised bearing pins resist wear, especially under off-road conditions

- Extended bushings reduce friction, improve power transmission
- Gold-colored side plates help reduce corrosion
- The perfect match for Renthal sprockets
- Clip type link included

DESCRIPTION	PART #	DESCRIPTION	PART #	DESCRIPTION	PART #
102 links	1221-0300	116 links	R1-520-116	120 links	R1-520-120
114 links	R1-520-114	118 links	1221-0296	Clip connecting link	R1-520-ML



520 R3-3 OFFROAD SRS CHAIN

- Update to the R3 chain range; upgraded to the R4 ranges proven quad riveting manufacturing process
- Renthal's SRS (Self-Regulating Seals) system increases service life of chain
- Comes pre-stretched for less adjustment during break in
- Rivet link has also been changed to a hollow end to facilitate easier installation that does not require a Quad Stake Rivet tool to install
- High-carbon alloy steel pins, solid bushings and rollers, and shot peening of plates and rollers for increased fatigue resistance
- 520 pitch; average tensile strength 3366 kg (7420 lb)

DESCRIPTION	PART #	DESCRIPTION	PART #	DESCRIPTION	PART #
102 links	1224-0216	116 links	1222-0452	Repl. rivet link	1222-0454
112 links	1224-0208	118 links	1224-0205	Repl. clip connecting link	1225-0467
114 links	1222-0451	120 links	1222-0453		



HANDLEBARS



0601-4076

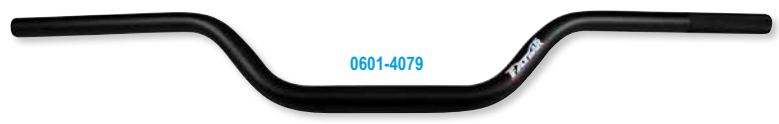

0601-4079

FATBAR®

- Aluminum 7010-T6 construction with unbraced design
- Same Offroad Fatbar® make and design
- Shot peened anodized finish
- Laser-etched positioning grid
- Tapered outer wall design; 28,6 mm (1 1/8") clamping diameter with 22 mm (7/8") control ends
- Bar pad not included

DESCRIPTION	END RISE (HEIGHT)	RISE	WIDTH	CENTER WIDTH	PULLBACK	BLACK
Street Fighter	99 mm (3,9")	64 mm (2,5")	77 cm (30,3")	12 cm (4,7")	71 mm (2,8")	0601-4076
Street Naked	10,5 cm (4,1")	71 mm (2,8")	78 cm (30,7")	14 cm (5,5")	86,5 mm (3,4")	0601-4079



0601-0241



0601-0245



0601-0246



0601-3944

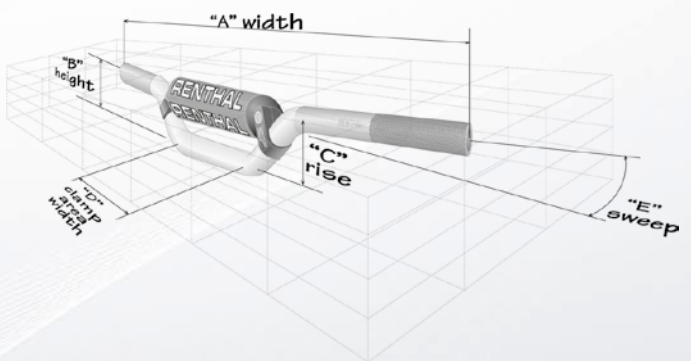

22 MM (7/8") STREET HANDLEBARS

- 22 mm (7/8") external diameter to fit all standard sized clamps and controls
- Exclusive aerospace aluminum 7010-T6 alloy is precisely engineered for the best combination of strength and fatigue reduction
- High-impact strength, lightweight and vibration absorbing
- Anodized to protect against corrosion

DESCRIPTION	END RISE (HEIGHT)	RISE	WIDTH	CENTER WIDTH	PULLBACK	GRAY	GOLD	SILVER	BLACK
High	12 cm (4,8")	11 cm (4,2")	72 cm (28,4")	19 cm (7,4")	11 cm (4,2")	-	-	0601-0244	0601-5192
Medium	12 cm (4,6")	86,5 mm (3,4")	73,5 cm (29")	19 cm (7,4")	11 cm (4,2")	-	-	0601-0241	0601-5191
Low	11 cm (4,2")	76 mm (3")	74,5 cm (29,4")	19 cm (7,4")	12,5 cm (5")	-	-	0601-0238	0601-5190
Ultra Low	76 mm (3")	51 mm (2")	73,5 cm (29")	19 cm (7,4")	97 mm (3,8")	0601-0245	0601-0246	0601-0247	0601-5193
Road Sports	0 mm (0")	0 mm (0")	72,5 cm (28,5")	21,5 cm (8,5")	61 mm (2,4")	-	-	-	0601-3944 ¹
Street Fighter (w/ crossbar)	10 cm (4")	61 mm (2,4")	77 cm (30,2")	20 cm (7,8")	81 mm (3,2")	-	-	-	0601-2673
Road Wide	60 mm (2,4")	43 mm (1,7")	79 cm (31")	14 cm (5,5")	68 mm (2,7")	-	-	-	0601-5189

¹ Not compatible with road brace.



0634-0001

0634-0002

0634-0004

0634-0005

0634-0481

HANDLEBAR END PLUGS FOR 22 MM (7/8") BARS

- Ultralight CNC-machined from 2011-T3 aluminum
- Each set includes an extra adapter sleeve for mounting in either aluminum (14 mm ID) or steel (17 mm) handlebars

COLOR	PART #	COLOR	PART #	COLOR	PART #
Gray	0634-0001	Red	0634-0004	Titanium	0634-0481
Gold	0634-0002	Blue	0634-0005		



0630-0593

REINFORCED DUAL-COMPOUND GRIPS

- The most advanced grip available
- Feature aramid fibers in a soft compound
- Last three times longer than regular soft grips
- Available in standard full diamond pattern
- Sold in pairs

DESCRIPTION	PART #	DESCRIPTION	PART #	DESCRIPTION	PART #	DESCRIPTION	PART #
29 mm	0630-0593	32 mm	0630-0762	29 mm	0630-0592	32 mm	0630-0761



0630-0592

DUAL-COMPOUND GRIPS

- Renthal Dual Layer Grips combine the durability of Renthal Firm Compound Grips with the feel and absorption qualities of the Renthal range of softer compound grips
- Firm compound is used for the flange, inner sleeve and outer-end of the grip for maximum durability; softer compounds are used for outer diameter of the grip, which is in direct contact with the palm, fingers and thumb
- Feature a smaller inner flange and a pre-cut hole in the end to accommodate bar ends
- Available in full diamond pattern in black/gray color
- Available in 29 mm and 32 mm
- Sold in pairs



0630-0643



0630-0644

SINGLE-COMPOUND GRIPS

- 29 mm full diamond design
- Extra firm grip is for long distance touring
- Firm grip has the same feel as a stock grip, very strong with good resistance to tearing
- Soft grip gives a very comfortable ride with great feel
- Medium grip is a compromise between soft and firm
- Sold in pairs



0630-0645



0630-2079

DESCRIPTION	PART #	DESCRIPTION	PART #	DESCRIPTION	PART #	DESCRIPTION	PART #
Soft	0630-0643	Medium	0630-0644	Firm	0630-0645	Extra Firm	0630-2079

STREET SPROCKETS

- CNC-machined (not stamped) and feature a computer-aided ultra-light design to reduce unsprung weight and increase power transfer
- Rear sprockets made from high-strength, specially enhanced 7075-T6 aluminum that is 33% lighter than steel to further reduce weight and increase power transfer without sacrificing strength
- Rear sprockets also feature a special tooth profile that allows the chain to roll easily on and off the sprocket for longer wear, less noise and more power
- Front sprockets made from case-hardened, core-refined nickel-chrome-molybdenum alloy steel for the ultimate combination of strength and hardness



FITS MODEL	CHAIN SIZE	STOCK GEARING	FRONT SIZE	PART #	REAR SIZE	PART #	OPTIONAL COLOR
APRILIA							
RS125 06-11	520-	17-40	-	-	40	1110-0074	
					44	1110-0081	
Pegaso Strada 05-10	520-	15-44	14	1212-1672	40	1110-0074	
Pegaso Factory 07-10		15-44	15	1212-1675	44	1110-0081	
Pegaso 05-09 (not Strada/Factory)		15-44					
750 Dorsoduro 10-16	525-	-	-	-	42	1110-0067	
750 SL Shiver 07-16							
Mana/GT 08-13							
Dorsoduro 900 18							
Shiver 900 17-18							
1100 V4 Tuono/Factory 16-17							
1200 Caponord/Rally 13-17							
1200 Dorsoduro 11							
SL1000 Falco 00-04	525-	17-41	15	1212-1615	42	1110-0067	
RSV Tuono 1000 04		17-40	16	1212-1611			
RSV 1000 Mille/R/SP 98-09		17-40	17	1212-1612			
RSV4 1000 15-18		16-41					
RSV4/Factory 11-16		16-42					
Tuono V4 11 Factory 17		15-42					
Tuono V4 1100 RR 17-18		15-42					
Tuono V4/V4R/APRC 11-15		16-42					
Tuono/Tuono Racing 06-11		16-40					
BMW							
F650GS 99-07	520-	16-46	16	1212-1645	-	-	
G650GS/GS650 Serto 11-16							
F650GS XC 07-08							
F650GS X Moto 07-08	520-	16-46	16	1212-1645	40	1110-0074	
					44	1110-0081	
F650GS 08-11	525-	-	15	1212-1615	-	-	
F700GS 13-18			16	1212-1611			
F800GS 09-18			17	1212-1612			
S1000R/Sport 14	525-	17-45	16	1212-1596	45	1110-0071	
S1000RR 10-11		17-44	17	1212-1594			
S1000RR 12-14		17-45					
S1000R/RR/Sport 15-18 (cast wheel)		17-45					
S1000XR 15-18 (cast wheel)		17-45					
S1000RR HP4 13-14	525-	17-44	16	1212-1596	-	-	
S1000 15-18 (all w/ forged wheel)		17-44	17	1212-1594			
CCM							
GP450 13-17	520-	-	-	-	42	1211-2519	
					44	1211-2522	
HONDA							
CB125F 15-17	428-	16-44	15	1212-1589	44	1110-0084	
CB125R 11-17		15-44					
CBR125R 04-10	428-		15	1212-1589	-	-	
CBF236 09-13							
XL125V Varadero 01-13	520-	-	-	-	43	1110-0078	
CRF250L 13-17	520-	14-40	13	1212-1677	40	1211-1194	
CRF250M 13-15		14-39			44	1211-2527	
					48	1211-2514	■ Black
					48	1211-2511	■ Red
					49	1211-2513	■ Black
					49	1211-2510	■ Red
					50	1211-2512	■ Black
					50	1211-2509	■ Red



FITS MODEL	CHAIN SIZE	STOCK GEARING	FRONT SIZE	PART #	REAR SIZE	PART #	OPTIONAL COLOR
HONDA (CONT.)							
CB300F 18-19	520-	-	13	1212-1677	-	-	
CB300R 19-20							
CBR300R 14-18							
CMX 300 Rebel 18							
CB500/S 97-03	525-	15-42	15	1212-1616	42	1110-0072	
CB500F 13-18	520-	15-41	15	1212-1629	41	1211-1687	
CB500X 13-18		15-42			42	1211-1688	
CBR500R 13-18		15-41			43	1211-1689	
					44	1211-1690	
CBF500/ABS 04-08	525-	15-41	15	1212-1616	41	1211-1687	
					42	1211-1688	
					43	1211-1689	
					44	1211-1690	
CMX500 17-18	520-	-	15	1212-1629	-	-	
CB600F Hornet 98-06	525-	15-42	14	1212-1619	41	1211-1687	
CBF600 Faired 04-07		15-43	15	1212-1620	42	1211-1688	
					43	1211-1689	
					44	1211-1690	
CB600F Hornet 07-13	525-	16-43	15	R315U-525-15	41	1211-1687	
CBF600/S/ABS 08-11		16-42	16	R315U-525-16	42	1211-1688	
CBR600F 11-13		16-43			43	1211-1689	
CBR600F4 99-00		16-44			44	1211-1690	
CB650F 14-18		15-42					
CBR650F 14-18		15-42					
CBR900RR 96-99		16-42					
XL1000 Varadero 99-13		16-47					
(525 to 520 conversion sprockets)	-	-	15	R315U-520-15	40	1110-0073	
			16	R315U-520-16	42	R411U-520-42-HA	
					44	1110-0080	
					46	R411U-520-46-HA	
CB600F 599 07-13	525-	16-43	15	R315U-525-15	43	1211-1689	
			16	R315U-525-16	44	1211-1690	
CBR600F2/F3 91-98	-	-	-	-	43	R240U-530-43-HA	
CB900F 02-08					44	R240U-530-44-HA	
CBR900RR 92-95							
CBF1000 11-16							
CBF1000F/ABS 06-10							
VTR 1000F 98-05							
CB1100 13-18							
CB1100S 00-02							
CBR1100XX 97-08							
CB1300F/S ABS 03-13							
CBR600F3 97-98	525-	-	-	-	43	1211-1689	
					44	1211-1690	
CBR600F4 99-00	525-	16-44	15	R315U-525-15	43	1211-1689	
			16	R315U-525-16	44	1211-1690	
CBR600F4i 01-06	525-	16-45/46	15	R315U-525-15	41	1110-0066	
CBR600RR 03-06		16-42	16	R315U-525-16	42	R411U-525-42-HA	
CBR600RR 07-09		16-41			44	R411U-525-44-HA	
CBR600RR 10-19		16-41			45	R411U-525-45-HA	
(525 to 520 conversion sprockets)	-	-	15	R315U-520-15	40	1110-0073	
			16	R315U-520-16	42	R411U-520-42-HA	
					44	1110-0080	
					46	R411U-520-46-HA	
XR600R 92-00	520-	-	-	-	40	1211-1194	
XR650L 93-12					44	1211-2527	
XR650L 13-17					48	1211-2514	■ Black
					48	1211-2511	■ Red
					49	1211-2513	■ Black
					49	1211-2510	■ Red
					50	1211-2512	■ Black
					50	1211-2509	■ Red
FMX650 05-08	520-	14-42	14	1212-1672	-	-	
NX650 95-01			15	1212-1675			
SLR650 97-00							
CTX700 18	520-	-	-	-	41	1110-0075	
NC700 SA 12-13					43	1110-0077	
NC750S/X 18							



SPROCKETS



FITS MODEL	CHAIN SIZE	STOCK GEARING	FRONT SIZE	PART #	REAR SIZE	PART #	OPTIONAL COLOR
HONDA (CONT.)							
CB750 FI 92-02	525-	15-40	15 16	R315U-525-15 R315U-525-16	-	-	
CB750 92-02	525-	-	-	-	42	1110-0072	
XRV750 Africa Twin 93-03							
VF750 83	530-	17-44	16 17 18	1212-1608 R310U-530-17 1212-1591	-	-	
VFR800 Interceptor 98-01	530-	17-43	16 17 18	1212-1608 R310U-530-17 1212-1591	-	-	
VFR800 Interceptor 02-13	530-	16-43	16 17 18	1212-1608 R310U-530-17 1212-1591	-	-	
VFR800 02-11	530-	16-44	16	1212-1608	43	1110-0063	
VFR800X Crossrunner 11-14		16-44	17 18	R310U-530-17 1212-1591	44	1110-0054	
CBR900RR 93-95	530-	16-42	15 16	R315U-530-15 R315U-530-16	-	-	
CBR900RR 96-99	525-	16-42	15 16	R315U-525-15 R315U-525-16	-	-	
CB919 02-07	530-	16-43	15 16	R315U-530-15 R315U-530-16	-	-	
CBR929RR 00-01	530-	16-43	15	R315U-530-15	40	R411U-530-40-HA	
CBR954RR 02-03		16-43	16	R315U-530-16	42 43	R411U-530-42-HA 1110-0065	
(530 to 520 conversion sprockets)	-		15 16	R315U-520-15 R315U-520-16	40 42 44 46	1110-0073 R411U-520-42-HA 1110-0080 R411U-520-46-HA	
CB1000 94-95	530-	17-42	16	1212-1608	-	-	
CBR1000 87-96		17-41/42/43	17	R310U-530-17			
VF1000 84		17-43	18	1212-1591			
RC51 00-06	530-	16-40	15	R315U-530-15	40	R411U-530-40-HA	
CBR1000RR 04-05		16-41	16	R315U-530-16	42	R411U-530-42-HA	
CBR1000RR 06-16		16-42			43	1110-0065	
(530 to 520 conversion sprockets)	-		15 16	R315U-520-15 R315U-520-16	40 42 44 46	1110-0073 R411U-520-42-HA 1110-0080 R411U-520-46-HA	
CBR1000S 18	525-	16-44	15 16	R315U-525-15 R315U-525-16	41 42 44 45	1110-0066 R411U-525-42-HA R411U-525-44-HA R411U-525-45-HA	
(525 to 520 conversion sprockets)	520-		15 16	R315U-520-15 R315U-520-16	40 42 44 46	1110-0073 R411U-520-42-HA 1110-0080 R411U-520-46-HA	
CB1000R/ABS 08-17	530-	16-44	15 16	R315U-530-15 R315U-530-16	43 44	1110-0063 1110-0054	
XL1000 Varadero 99-13	525-	16-47	15 16	R315U-525-15 R315U-525-16	47	1110-0057	
(525 to 520 conversion sprockets)	520-		15 16	R315U-520-15 R315U-520-16	41 43	1110-0075 1110-0077	
VTR1000 Superhawk 98-05	530-	16-40	15 16	R315U-530-15 R315U-530-16	-	-	
CBR1100XX 97-03	530-	17-44 17-43	16 17 18	1212-1608 R310U-530-17 1212-1591	-	-	
CRF1000L Africa Twin 16-17	525-	16-42	15 16	R315U-525-15 R315U-525-16	42	1110-0072	
KAWASAKI							
EX250 88-07	520-	-	-	-	42 43 46 47	1110-0076 R210U-520-43-HA R210U-520-46-HA R210U-520-47-HA	

FITS MODEL	CHAIN SIZE	STOCK GEARING	FRONT SIZE	PART #	REAR SIZE	PART #	OPTIONAL COLOR
KAWASAKI (CONT.)							
Z250SL/Ninja 250SL 15-17	520-	14-42	14	1212-0500	42	1110-0076	
Ninja 250R 08-12		14-43			43	R210U-520-43-HA	
Ninja 300R 13-17		14-42			46	R210U-520-46-HA	
Versys-X 300 17-18		14-46			47	R210U-520-47-HA	
Z300 15-17							
Ninja 400 18-19							
EX500/500 Ninja 87-04	520-	16-42	-	-	42	1110-0076	
					43	R210U-520-43-HA	
					46	R210U-520-46-HA	
					47	R210U-520-47-HA	
ZR550 91	520-	16-38	-	-	42	1110-0076	
					43	R210U-520-43-HA	
					46	R210U-520-46-HA	
					47	R210U-520-47-HA	
ZX-6D 90-93	530-	15-45	13	1212-1668	-	-	
ZX-6E 93-04		16-48	14	R289U-530-14 ¹			
			14	1212-1670			
			15	R289U-530-15 ¹			
			15	1212-1669			
			16	R289U-530-16 ¹			
			16	1212-1646			
			17	1212-1644			
			17	1212-1622 ¹			
			18	1212-1618			
ZX-6R 03-04	520-	15-40	-	-	43	R184U-520-43-HA	
ZX-6R 05-06		15-43			45	R184U-520-45-HA	
ZX-6RR 03-04		15-40			46	R184U-520-46-HA	
ZX-6RR 05		15-43					
ZX-6R 07-19	520-	16-43	14	1212-1586	43	R184U-520-43-HA	
			15	1212-0316	45	R184U-520-45-HA	
			16	1212-0317	46	R184U-520-46-HA	
ZZR600 93-06	530-	15-45	13	1212-1668	-	-	
			14	R289U-530-14 ¹			
			14	1212-1670			
			15	R289U-530-15 ¹			
			15	1212-1669			
			16	R289U-530-16 ¹			
			16	1212-1646			
			17	1212-1644			
			17	1212-1622 ¹			
			18	1212-1618			
W650 00-02	525-	15-39	14	1212-1665	-	-	
			15	1212-1667			
			15	R289U-525-15 ¹			
			16	R289U-525-16 ¹			
			16	1212-1647			
			17	1212-1643			
KLE650A Versys 07-14	520-	-46	-	-	43	R184U-520-43-HA	
					45	R184U-520-45-HA	
					46	R184U-520-46-HA	
ZR750 91-98	525-	15-39	14	1212-1665	-	-	
ZR-7/S 99-04		16-38	15	1212-1667			
			15	R289U-525-15 ¹			
			16	R289U-525-16 ¹			
			16	1212-1647			
			17	1212-1643			
ZR750 04-10	520-	15-43	14	1212-1614	43	R184U-520-43-HA	
Z750R 11-13		16-43	15	1212-1613	45	R184U-520-45-HA	
Z800 13-17					46	R184U-520-46-HA	
ZX750H1 ZX-7 89	530-	16-46	14	1212-1665	-	-	
			15	1212-1667			
			15	R289U-525-15 ¹			
			16	R289U-525-16 ¹			
			16	1212-1647			
			17	1212-1643			

¹ Ultraight

FITS MODEL	CHAIN SIZE	STOCK GEARING	FRONT SIZE	PART #	REAR SIZE	PART #	OPTIONAL COLOR
KAWASAKI (CONT.)							
ZX750F ZX-7 87-89	530-	16-47	13	1212-1668	-	-	
			14	R289U-530-14 ¹			
			14	1212-1670			
			15	R289U-530-15 ¹			
			15	1212-1669			
			16	R289U-530-16 ¹			
			16	1212-1646			
			17	1212-1644			
			17	1212-1622 ¹			
ZX750H2 ZX-7 90	530-	16-46	13	1212-1668	-	-	
			14	R289U-530-14 ¹			
			14	1212-1670			
			15	R289U-530-15 ¹			
			15	1212-1669			
			16	R289U-530-16 ¹			
			16	1212-1646			
			17	1212-1644			
			17	1212-1622 ¹			
ZX750J ZX-7 91-93	530-	16-45	13	1212-1668	-	-	
			14	R289U-530-14 ¹			
			14	1212-1670			
			15	R289U-530-15 ¹			
			15	1212-1669			
			16	R289U-530-16 ¹			
			16	1212-1646			
			17	1212-1644			
			17	1212-1622 ¹			
ZX750K ZX-7R 91-93	530-	16-42	13	1212-1668	-	-	
			14	R289U-530-14 ¹			
			14	1212-1670			
			15	R289U-530-15 ¹			
			15	1212-1669			
			16	R289U-530-16 ¹			
			16	1212-1646			
			17	1212-1644			
			17	1212-1622 ¹			
ZX750L ZX-7 93-96	530-	16-44	13	1212-1668	-	-	
			14	R289U-530-14 ¹			
			14	1212-1670			
			15	R289U-530-15 ¹			
			15	1212-1669			
			16	R289U-530-16 ¹			
			16	1212-1646			
			17	1212-1644			
			17	1212-1622 ¹			
ZX750M ZX-7R 93-94	530-	16-41	13	1212-1668	-	-	
			14	R289U-530-14 ¹			
			14	1212-1670			
			15	R289U-530-15 ¹			
			15	1212-1669			
			16	R289U-530-16 ¹			
			16	1212-1646			
			17	1212-1644			
			17	1212-1622 ¹			
ZX750P ZX-7R 96-03	525-108	16-43	13	1212-1668	-	-	
			14	R289U-530-14 ¹			
			14	1212-1670			
			15	R289U-530-15 ¹			
			15	1212-1669			
			16	R289U-530-16 ¹			
			16	1212-1646			
			17	1212-1644			
			17	1212-1622 ¹			
ZX-7RR 96-98	525-108	16-42	13	1212-1668	-	-	
			14	R289U-530-14 ¹			
			14	1212-1670			
			15	R289U-530-15 ¹			
			15	1212-1669			
			16	R289U-530-16 ¹			
			16	1212-1646			
			17	1212-1644			
			17	1212-1622 ¹			
(525 to 520 conversion sprockets)	520-		15	R385U-520-15 ¹	43	R184U-520-43-HA	
			16	R385U-520-16 ¹	45	R184U-520-45-HA	
			16	R385U-520-16 ¹	46	R184U-520-46-HA	
VN800 Classic 96-06	530-	17-42	13	1212-1668	-	-	
			14	R289U-530-14 ¹			
			14	1212-1670			
			15	R289U-530-15 ¹			
			15	1212-1669			
			16	R289U-530-16 ¹			
			16	1212-1646			
			17	1212-1644			
			17	1212-1622 ¹			
VN800 Drifter 99-04	530-	17-40	13	1212-1668	-	-	
			14	R289U-530-14 ¹			
			14	1212-1670			
			15	R289U-530-15 ¹			
			15	1212-1669			
			16	R289U-530-16 ¹			
			16	1212-1646			
			17	1212-1644			
			17	1212-1622 ¹			
ZX-9R 94-97	530-	16-44	13	1212-1668	-	-	
			14	R289U-530-14 ¹			
			14	1212-1670			
			15	R289U-530-15 ¹			
			15	1212-1669			
			16	R289U-530-16 ¹			
			16	1212-1646			
			17	1212-1644			
			17	1212-1622 ¹			
ZX-9R 98-01	530-	16-41	13	1212-1668	-	-	
			14	R289U-530-14 ¹			
			14	1212-1670			
			15	R289U-530-15 ¹			
			15	1212-1669			
			16	R289U-530-16 ¹			
			16	1212-1646			
			17	1212-1644			
			17	1212-1622 ¹			
ZX-9R 02-04	525-	16-41	15	1212-1623	40	R184U-525-40-HA	
			16	1212-0036	41	R184U-525-41-HA	
			16	1212-0036	42	R184U-525-42-HA	
			15	1212-1623	40	R184U-525-40-HA	
			16	1212-0036	41	R184U-525-41-HA	
			16	1212-0036	42	R184U-525-42-HA	
			15	1212-1623	40	R184U-525-40-HA	
			16	1212-0036	41	R184U-525-41-HA	
			16	1212-0036	42	R184U-525-42-HA	
LV1000 05-06	525-	17-41	14	1212-1665	42	R409U-525-42-HA	
			15	1212-1667	43	1110-0069	
			15	R289U-525-15 ¹	45	R409U-525-45-HA	
			16	R289U-525-16 ¹	47	1110-0058	
			16	1212-1647			
			17	1212-1643			
			15	1212-1623	40	R184U-525-40-HA	
			16	1212-0036	41	R184U-525-41-HA	
			16	1212-0036	42	R184U-525-42-HA	
Z1000 03-06	525-	16-41	15	1212-1623	40	R184U-525-40-HA	
			16	1212-0036	41	R184U-525-41-HA	
			15	1212-1623	40	R184U-525-40-HA	
			16	1212-0036	41	R184U-525-41-HA	
			15	1212-1623	40	R184U-525-40-HA	
			16	1212-0036	41	R184U-525-41-HA	
			16	1212-0036	42	R184U-525-42-HA	
Z1000 07-09	525-	15-40	15	1212-1623	40	R184U-525-40-HA	
			16	1212-0036	41	R184U-525-41-HA	
			15	1212-1623	40	R184U-525-40-HA	
			16	1212-0036	41	R184U-525-41-HA	
			15	1212-1623	40	R184U-525-40-HA	
			16	1212-0036	41	R184U-525-41-HA	
			16	1212-0036	42	R184U-525-42-HA	
Z1000 10-13	525-	15-42	15	1212-1623	40	R184U-525-40-HA	
			16	1212-0036	41	R184U-525-41-HA	
			15	1212-1623	40	R184U-525-40-HA	
			16	1212-0036	41	R184U-525-41-HA	
			15	1212-1623	40	R184U-525-40-HA	
			16	1212-0036	41	R184U-525-41-HA	
			16	1212-0036	42	R184U-525-42-HA	
Z1000 14-17	525-	15-43	15	1212-1623	40	R184U-525-40-HA	
			16	1212-0036	41	R184U-525-41-HA	
			15	1212-1623	40	R184U-525-40-HA	
			16	1212-0036	41	R184U-525-41-HA	
			15	1212-1623	40	R184U-525-40-HA	
			16	1212-0036	41	R184U-525-41-HA	
			16	1212-0036	42	R184U-525-42-HA	
Z1000/R 15-19	525-	15-43	15	1212-1623	40	R184U-525-40-HA	
			16	1212-0036	41	R184U-525-41-HA	
			15	1212-1623	40	R184U-525-40-HA	
			16	1212-0036	41	R184U-525-41-HA	
			15	1212-1623	40	R184U-525-40-HA	
			16	1212-0036	41	R184U-525-41-HA	
			16	1212-0036	42	R184U-525-42-HA	
Z1000SX 15-19	525-	15-41	15	1212-1623	40	R184U-525-40-HA	
			16	1212-0036	41	R184U-525-41-HA	
			15	1212-1623	40	R184U-525-40-HA	
			16	1212-0036	41	R184U-525-41-HA	
			15	1212-1623	40	R184U-525-40-HA	
			16	1212-0036	41	R184U-525-41-HA	
			16	1212-0036	42	R184U-525-42-HA	

¹ Ultralight

FITS MODEL	CHAIN SIZE	STOCK GEARING	FRONT SIZE	PART #	REAR SIZE	PART #	OPTIONAL COLOR	
KAWASAKI (CONT.)								
KLZ1000 Versys 12-18	525-	15-43	15	1212-1623	43	R184U-520-43-HA		
			16	1212-0036	45	R184U-520-45-HA		
ZRX1100 97-00	530-		17	1212-1610 ¹	-	-		
ZX-10R 04-10	525-110	17-40	14	1212-1665	40	R184U-525-40-HA		
ZX-10R 11-18		17-39	15	1212-1667	41	R184U-525-41-HA		
			15	R289U-525-15 ¹	42	R184U-525-42-HA		
			16	R289U-525-16 ¹				
			16	1212-1647				
	17	1212-1643						
(525 to 520 conversion sprockets)	17-40	15	R385U-520-15 ¹	43	R184U-520-43-HA			
		16	R385U-520-16 ¹	45	R184U-520-45-HA			
				46	R184U-520-46-HA			
ZZR-1100 95-01	530-	17-	17	1212-1648	-	-		
ZX-12R 00-05		17-46						
ZZR-1200 02-05		17-44						
ZX-14 06-11		17-41						
ZX-14 12-19		17-42						
ZRX1200R 01-08		17-42	17	1212-1610 ¹	-	-		
ZRX1200S 01-06		17-42						
KTM								
125 Duke 11-13	520-	14-45	14	1212-1604	43	1110-0078		
200 Duke 13		14-45						
620 LC4/E 97-98	-	-	-	-	50	1211-0047	■ Black	
					50	1211-1333	■ Blue	
					50	1211-2476	■ Orange	
620 Adventurer 98	-	-	-	-	45	1211-0078		
701 Enduro 17-19	-	-	-	-	45	1211-2471	■ Orange	
					46	1211-0079		
					46	1211-2472	■ Orange	
640 Adventure R 99-06	520-	16-42	15	1212-1655	42	1211-2519		
640 Duke 00-03		17-38	16	1212-1625	42	1211-2469	■ Orange	
640 Duke 04-06		17-42			44	1211-2522		
640 LC4-E Enduro 00-06		16-42			44	1211-2470	■ Orange	
640 LC4 Supermoto 99-06		17-42						
660 Rally Factory/Special Raid 02-04		16-44						
660 SMC 03-04		16-38						
660 SMC 05-06		17-40						
690 Duke/R 08-19		16-40						
690 Enduro R 10-18		16-45						
690 Enduro 19		16-42						
690 SMC/R 08-10, 13-17		16-42						
690 Supermoto 07-08		16-40						
790 Duke 19		16-						
950/990 Adventure 04-12		525-	17-42	16	1212-1593	-	-	
LC8 Supermoto/R 07-09			16-42	17	1212-1609			
950 Super Enduro R 07-09			16-42					
990 Supermoto 08-13			17-41					
990 Super Duke/R 08-13			17-38					
990 SMR 13								
1050 Adventure 15-16	17-42							
1090 Adventure/R 17-18	17-42							
1190 RC-8/8R 08-14	17-38							
1190 Adventure/R 13-16	17-42							
1290 Super Adventure/R/S 15-19	17-42							
1290 Super Duke 16-19								
SUZUKI								
RGV250 89-90	520-			12	R289-520-12	-	-	
RGV250 91-96		14-43	13	R289-520-13				
GS500 89-93		16-39	14	R289-520-14				
SFV650 Gladius 09-15		15-46	15	R289-520-15				
			16	1212-1666				
Inazuma 12-15	520-	-	-	-	44	1110-0079		
GSX250R 17-19		-	-	-	45	1110-0082		
V-Strom 250 17-19		-	-	-				
DR-Z400SM 05-19	520-	-	-	-	41	1211-2508		
DR-Z400E 00-11		-	-	-	44	1211-2521		

¹ Ultraight

FITS MODEL	CHAIN SIZE	STOCK GEARING	FRONT SIZE	PART #	REAR SIZE	PART #	OPTIONAL COLOR
SUZUKI (CONT.)							
GSF600/S Bandit 95-04	530-	15-47	13	1212-1668	-	-	
GSX600F 89-92		14-46	14	R289U-530-14 ¹			
GSX600F 93-97		14-45	14	1212-1670			
GSX600F 98-04		15-47	15	R289U-530-15 ¹			
RF600 94-96		14-43	15	1212-1669			
			16	R289U-530-16 ¹			
			16	1212-1646			
			17	1212-1644			
			17	1212-1622 ¹			
			18	1212-1618			
GSR600 06-10	525-	15-47	14	1212-1665	42	R409U-525-42-HA	
GSX-R600 01-10		15-47	15	1212-1667	43	1110-0069	
DL650 V-Strom/ABS 04-19		15-47	15	R289U-525-15 ¹	45	R409U-525-45-HA	
GSR 750/ABS 11-16		17-42	16	R289U-525-16 ¹	47	1110-0058	
GSX-R750 00-05		17-42	16	1212-1647			
GSX-R750 06-10		17-45	17	1212-1643			
GSX-S750 11-16		17-42					
V-Strom DL 1000 02-19		17-41					
V-Strom 1000 14-17		17-41					
GSX-R600 97	525-	16-45	14	1212-1665	-	-	
GSX-R600 98-00		16-46	15	1212-1667			
			15	R289U-525-15 ¹			
			16	R289U-525-16 ¹			
			16	1212-1647			
			17	1212-1643			
GSX-R600 01-05	525-	16-45	14	1212-1665	-	-	
GSX-R600 06-09		16-43	15	1212-1667			
			15	R289U-525-15 ¹			
			16	R289U-525-16 ¹			
			16	1212-1647			
			17	1212-1643			
GSX-R600 11-14	525-	16-43	14	1212-1665	-	-	
			15	1212-1667			
			15	R289U-525-15 ¹			
			16	R289U-525-16 ¹			
			16	1212-1647			
			17	1212-1643			
(525 to 520 conversion sprockets)	520-	16-43	15	R385U-520-15 ¹	42	1110-0076	
			16	R385U-520-16 ¹	43	R210U-520-43-HA	
					46	R210U-520-46-HA	
ER650/EX650 06-16	520-	15-46	12	R289-520-12	-	-	
Versys 650 07-19			13	R289-520-13			
Vulcan S 650 15-17			14	R289-520-14			
Z650 17-19			15	R289-520-15			
Ninja 650 17-19			16	1212-1666			
GSF650/S 05-06	530-	15-47	13	1212-1668	-	-	
GSX750F 98-04			14	R289U-530-14 ¹			
			14	1212-1670			
			15	R289U-530-15 ¹			
			15	1212-1669			
			16	R289U-530-16 ¹			
			16	1212-1646			
			17	1212-1644			
			17	1212-1622 ¹			
			18	1212-1618			
GSF650/S 07-11	525-	15-48	14	1212-1665	44	R199U-525-44-HA	
GSX650F 08-16		15-48	15	1212-1667	45	R199U-525-45-HA	
SV650 99-07		15-45	15	R289U-525-15 ¹	48	1110-0059	
SV650S 99-09		15-44	16	R289U-525-16 ¹			
SV 650S Sport 10-15		15-45	16	1212-1647			
			17	1212-1643			
(525 to 520 conversion sprockets)	520-		15	R385U-520-15 ¹	44	1110-0079	
			16	R385U-520-16 ¹	45	1110-0082	
SV650 16-19	520-		12	R289-520-12	44	1110-0079	
SV650X 19			13	R289-520-13	45	1110-0082	
			14	R289-520-14			
			15	R289-520-15			
			16	1212-1666			

¹ Ultralight



FITS MODEL	CHAIN SIZE	STOCK GEARING	FRONT SIZE	PART #	REAR SIZE	PART #	OPTIONAL COLOR
SUZUKI (CONT.)							
GSX750F 89-96	530-	15-47	13	1212-1668	-	-	
GSX-R750 86-87		15-45	14	R289U-530-14 ¹			
GSX-R750 88-89		14-42	14	1212-1670			
			15	R289U-530-15 ¹			
			15	1212-1669			
			16	R289U-530-16 ¹			
			16	1212-1646			
			17	1212-1644			
			17	1212-1622 ¹			
GSX-R750 90-95	530-	15-42	15	1212-1618			
			13	1212-1668	-	-	
			14	R289U-530-14 ¹			
			14	1212-1670			
			15	R289U-530-15 ¹			
			15	1212-1669			
			16	R289U-530-16 ¹			
GSX-R750T 96-97	530-108	16-43	16	1212-1646			
			17	1212-1644			
			17	1212-1622 ¹			
			18	1212-1618			
			13	1212-1668	-	-	
			14	R289U-530-14 ¹			
			14	1212-1670			
GSX-R750W 98-99	525-	16-44	15	R289U-530-15 ¹			
			15	1212-1665	-	-	
			15	1212-1667			
			16	R289U-525-16 ¹			
			16	1212-1647			
			17	1212-1643			
			GSX-R750 01-09	525-	17-42 17-43	14	1212-1665
15	1212-1667						
15	R289U-525-15 ¹						
16	R289U-525-16 ¹						
16	1212-1647						
17	1212-1643						
GSX-R750 11-16	525-	17-45	14	1212-1665	43	1110-0068	
GSX-R750 17-19		17-44	15	1212-1667	45	1110-0070	
GSX-S750 17-19		17-43	15	R289U-525-15 ¹			
GSX-S1000/F 15-19		17-44	16	R289U-525-16 ¹			
			16	1212-1647			
			17	1212-1643			
(525 to 520 conversion sprockets)	520-	17-45	15	R385U-520-15 ¹	42	1110-0076	
			16	R385U-520-16 ¹	43	R210U-520-43-HA	
					46	R210U-520-46-HA	
					47	R210U-520-47-HA	
VZ800 97-01	530-	15-48	13	1212-1668	-	-	
			14	R289U-530-14 ¹			
			14	1212-1670			
			15	R289U-530-15 ¹			
			15	1212-1669			
			16	R289U-530-16 ¹			
			16	1212-1646			
			17	1212-1644			
			17	1212-1622 ¹			
DL1000 V-Strom 02-10	525-	17-41	18	1212-1618			
			14	1212-1665	-	-	
			15	1212-1667			
			15	R289U-525-15 ¹			
			16	R289U-525-16 ¹			
			16	1212-1647			
17	1212-1643						

¹ Ultralight

FITS MODEL	CHAIN SIZE	STOCK GEARING	FRONT SIZE	PART #	REAR SIZE	PART #	OPTIONAL COLOR
SUZUKI (CONT.)							
GSX-R1000 01-06	530-	17-42	13	1212-1668	42	R409U-530-42-HA	
GSX-R1000 07-08		17-43	14	R289U-530-14 ¹	43	1211-0314	
SV1000 03-06		17-40	14	1212-1670	44	R409U-530-44-HA	
			15	R289U-530-15 ¹	45	1110-0055	
			15	1212-1669			
			16	R289U-530-16 ¹			
			16	1212-1646			
			17	1212-1644			
			17	1212-1622 ¹			
			18	1212-1618			
GSX-R1000 09-16	530-	17-42	17	1212-0385 ¹	42	1110-0061	
			18	1212-0386 ¹	44	R210U-530-44-HA	
					45	R210U-530-45-HA	
					46	1110-0056	
					48	1110-0053	
GSX 1300R Hayabusa 08-19	530-	17-42	17	1212-0385 ¹	42	R409U-530-42-HA	
GSX1300BK B-King 08-11		18-43	18	1212-0386 ¹	43	1211-0314	
					44	R409U-530-44-HA	
					45	1110-0055	
GSX-R1000 17-18	525-	17-45	16	1212-1304	-	-	
			17	1212-1305			
TL1000S 97-00	530-	17-38	13	1212-1668	-	-	
TL1000R 98-02		17-39	14	R289U-530-14 ¹			
			14	1212-1670			
			15	R289U-530-15 ¹			
			15	1212-1669			
			16	R289U-530-16 ¹			
			16	1212-1646			
			17	1212-1644			
			17	1212-1622 ¹			
			18	1212-1618			
GSF1200/S Bandit 96-05	530-	15-45	13	1212-1668	-	-	
			14	R289U-530-14 ¹			
			14	1212-1670			
			15	R289U-530-15 ¹			
			15	1212-1669			
			16	R289U-530-16 ¹			
			16	1212-1646			
			17	1212-1644			
			17	1212-1622 ¹			
			18	1212-1618			
GSF1200/S Bandit 06	530-	15-45	13	1212-1668	42	R409U-530-42-HA	
GSF1250S/SA 07-16		18-43	14	R289U-530-14 ¹	43	1211-0314	
GSX1250FA 10-15		18-43	14	1212-1670	44	R409U-530-44-HA	
GSX1400 02-08		18-41	15	R289U-530-15 ¹	45	1110-0055	
			15	1212-1669			
			16	R289U-530-16 ¹			
			16	1212-1646			
			17	1212-1644			
			17	1212-1622 ¹			
			18	1212-1618			
GSX1300R Hayabusa 99-07	530-	17-40	13	1212-1668	-	-	
			14	R289U-530-14 ¹			
			14	1212-1670			
			15	R289U-530-15 ¹			
			15	1212-1669			
			16	R289U-530-16 ¹			
			16	1212-1646			
			17	1212-1644			
			17	1212-1622 ¹			
			18	1212-1618			
GSX1300R Hayabusa 08-19	530-	18-43	17	1212-0385 ¹	43	1211-0314	
GSX1300BK B-King 08-11			18	1212-0386 ¹	44	R409U-530-44-HA	
					45	1110-0055	
TRIUMPH							
T100 Bonneville 02-06	525-	17-43	17	1212-1605	42	R409U-525-42-HA	
T100 Bonneville 07-15		18-43	18	1212-1617	43	1110-0069	
					45	R409U-525-45-HA	
					47	1110-0058	

¹ Ultralight



FITS MODEL	CHAIN SIZE	STOCK GEARING	FRONT SIZE	PART #	REAR SIZE	PART #	OPTIONAL COLOR
TRIUMPH (CONT.)							
Speed Four 03-06	525-	-	-	-	42	R409U-525-42-HA	
600/650 Daytona 03-35					43	1110-0069	
TT600 00-03					45	R409U-525-45-HA	
					47	1110-0058	
T509 Speed Triple 97-01	530-	18-43	17	1212-0030	42	1110-0062	
T509 Speed Triple 02-10		18-42	18	1212-0031	43	1110-0064	
T595 Daytona 97-98		18-43	19	1212-0032			
675 Daytona 06-16	525-	16-47	14	1212-1665	50	1110-0060	
675 Street Triple 08-17		16-47	15	1212-1667			
765 Street Triple 18		16-50	15	R289U-525-15 ¹			
800 Tiger/XC 11-14		16-50	16	R289U-525-16 ¹			
800 Tiger XCA/XR/XCX 16-18		16-50	16	1212-1647			
750 Trident 91-96	530-	17-48	17	1212-0030	-	-	
750 Daytona 91-93		17-46	18	1212-0031			
			19	1212-0032			
800 Tiger XCX/XRX 15-17	525-	-	-	-	50	1110-0060	
800 Tiger XRT 17							
900 Thruxton Ace 16							
Bonneville AM 02-15	525-	17-42	17	1212-1605	42	1110-0072	
Speedmaster 03-15		18-42	18	1212-1617			
865 Scrambler 07-15	525-	18-43	17	1212-1605	42	R409U-525-42-HA	
865 Thruxton 07-15		18-43	18	1212-1617	43	1110-0069	
					45	R409U-525-45-HA	
					47	1110-0058	
900 Trident/Sprint 91-98	530-	17-46	17	1212-0030	-	-	
900 Trophy 91-93		17-45/46	18	1212-0031			
900 Trophy 94-00		17-43	19	1212-0032			
900 Tiger 99-00		18-48					
900/955 Tiger 01-04		18-46					
900/1000 Daytona 91-93		17-46					
900 Daytona 94-97		17-43					
900 Speed Triple 94-96		17-43					
900 Daytona Super 3 94		17-43					
900 Thunderbird/Sport 98-04		17-43					
900 Adventurer 96-98		17-43					
955 Daytona Centennial 02	530-	19-42	17	1212-0030	42	1110-0062	
955i Daytona 99-01, 03-06		18-42	18	1212-0031	43	1110-0064	
955 Speed Triple 97-01		18-43	19	1212-0032			
955 Speed Triple 02-16		18-42					
955 Sprint RS 04-05		18-43					
955 Sprint ST 99-04		18-43					
1050 Sprint ST/ABS 05-12		19-42					
1050 Sprint GT 12-16		19-42					
1050 Speed Triple 02-16		18-43					
955i Daytona 02	530-	19-44	17	1212-0030	42	R409U-530-42-HA	
955 Sprint RS 00-03		18-43	18	1212-0031	43	1211-0314	
955i Tiger 05-06		18-46	19	1212-0032	44	R409U-530-44-HA	
					45	1110-0055	
1050 Speed Triple 13-17	530-	-	-	-	42	1110-0062	
1050 Tiger Sport 13-17					43	1110-0064	
1200 Trophy 93	530-	18-43	17	1212-0030	-	-	
1200 Daytona 94-97		17-42	18	1212-0031			
1200 Trophy 91-93		18-45	19	1212-0032			
1200 Trophy 94-96		18-44					
1200 Trophy 97-98		18-42					
1200 Trophy 02		18-40					
T120 Bonneville 16	525-	-	-	-	50	1110-0060	
T120 1200 17							
1200 Bonneville Bobber 17							
1200 Thruxton/R 16-17							
YAMAHA							
MT-125 15-19	428-	14-48	14	1212-1590	48	1110-0085	
YZF-R 125 08-18		14-48					
WR125X/R 09-16	428	14-53	14	1212-1590	53	1110-0083	

¹ Ultralight

FITS MODEL	CHAIN SIZE	STOCK GEARING	FRONT SIZE	PART #	REAR SIZE	PART #	OPTIONAL COLOR
YAMAHA (CONT.)							
MT-03	520-	14-43	12	R289-520-12	42	1110-0076	
YZF-R3 15-20	520-	14-43	13	R289-520-13	43	R210U-520-43-HA	
			14	R289-520-14	46	R210U-520-46-HA	
			15	R289-520-15	47	R210U-520-47-HA	
			16	1212-1666			
GS500 E/F 94-08	520-	16-39	16	R321U-520-16	-	-	
FZR600 89-90	530-106	15-46	13	1212-1668	-	-	
FZR600 91-93		15-45	14	R289U-530-14 ¹			
			14	1212-1670			
			15	R289U-530-15 ¹			
			15	1212-1669			
			16	R289U-530-16 ¹			
			16	1212-1646			
			17	1212-1644			
			17	1212-1622 ¹			
			18	1212-1618			
YZF600R 96-03	530-	15-47	13	1212-1668	-	-	
FZS 600 Fazer 98-03		15-48	14	R289U-530-14 ¹			
			14	1212-1670			
			15	R289U-530-15 ¹			
			15	1212-1669			
			16	R289U-530-16 ¹			
			16	1212-1646			
			17	1212-1644			
			17	1212-1622 ¹			
			18	1212-1618			
FZ6 04-09	532-	16-46	15	1212-1641	42	1110-0061	
			16	1212-1626	44	R210U-530-44-HA	
					45	R210U-530-45-HA	
					46	1110-0056	
					48	1110-0053	
YZF-R6 99-02	530-	16-48	15	1212-1641	-	-	
			16	1212-1626			
YZF-R6 03-05 (532 to 520 conversion sprockets)	520-	-	15	1212-1641	42	1110-0076	
			16	1212-1626	43	R210U-520-43-HA	
					46	R210U-520-46-HA	
					47	R210U-520-47-HA	
YZF-R6 06-16	525-	16-45	15	1212-0255 ¹	43	1110-0068	
YZF-R6 17-18		16-46	15	1212-1642	45	1110-0070	
			16	1212-1624			
(525 to 520 conversion sprockets)	520-	16-45	15	1212-1640 ¹	42	1110-0076	
			16	1212-1621 ¹	43	R210U-520-43-HA	
					46	R210U-520-46-HA	
					47	R210U-520-47-HA	
MT-03 06-12	520-	15-47	14	1212-1672			
XT660R 04-14		15-47	15	1212-1675			
XT660X 04-14		15-47					
XT660Z Tenere 08-15		15-47					
YZF-R7 99-01	530-	16-43	15	1212-1641	42	1110-0061	
YZR1000 Thunder Ace 96-02			16	1212-1626	44	R210U-530-44-HA	
					45	R210U-530-45-HA	
					46	1110-0056	
					48	1110-0053	
XSR700 15-19	525-	16-43	15	1212-1136	43	1110-0068	
MT-07 14-19		16-43	16	1212-1137	45	1110-0070	
XTZ690 Tenere 700 20		16-46					
FJ-09 14-17		16-45					
FZ-09 14-17		16-45					
XSR900 16-19		16-45					
MT-09 14-19 (all)		16-45					
MT-10 16-19		16-43					
(525 to 520 conversion sprockets)	520-		15	1212-1600 ¹	42	1110-0076	
			16	1212-1599 ¹	43	R210U-520-43-HA	
					46	R210U-520-46-HA	
					47	R210U-520-47-HA	
FZ8/ABS 10-13	525-	16-	15	1212-1136	-	-	
TDM900 02-13		16-42	16	1212-1137			

¹ Ultralight



FITS MODEL	CHAIN SIZE	STOCK GEARING	FRONT SIZE	PART #	REAR SIZE	PART #	OPTIONAL COLOR
YAMAHA (CONT.)							
TDM850 99-01	525-	17-	14	1212-1665	-	-	
			15	1212-1667			
			15	R289U-525-15 ¹			
			16	R289U-525-16 ¹			
			16	1212-1647			
			17	1212-1643			
MXT850 Niken 18-19	525-	16-47	15	1212-1136	47	1110-0057	
YZF-R1/M 15-19		16-41	16	1212-1137			
(525 to 520 conversion sprockets)	520-		15	1212-1600 ¹	41	1110-0075	
			16	1212-1599 ¹	43	1110-0077	
FZ1 01-05	530-	16-44	15	1212-1649	42	1110-0061	
FZ1 06-15		17-45	16	1212-1627	44	R210U-530-44-HA	
			16	R309U-530-16	45	R210U-530-45-HA	
			17	1212-0033	46	1110-0056	
			17	1212-1628	48	1110-0053	
YZF-R1 98-03	530-	16-43	15	1212-1649	42	1110-0061	
YZF-R1 04-08		17-45	16	1212-1627	44	R210U-530-44-HA	
YZF-R1 09-14		17-47	16	R309U-530-16	45	R210U-530-45-HA	
			17	1212-0033	46	1110-0056	
			17	1212-1628	48	1110-0053	
YZF-R1 15-16	525-	16-43	15	1212-1136	-	-	
YZF-R1M 15-16			16	1212-1137			
YZFR1S 16							
FZ-10 17-18							
YZFR1S 17	525-	16-	15	1212-1136	-	-	
			16	1212-1137			
FJ1100 84-85	530-110	17-42	15	1212-1649	-	-	
			16	1212-1627			
			16	R309U-530-16			
			17	1212-0033			
			17	1212-1628			
FJ1200 86-90	530-110	17-40	15	1212-1649	-	-	
FJ1200 91-95		17-39	16	1212-1627			
			16	R309U-530-16			
			17	1212-0033			
			17	1212-1628			
MT-01 05-11	530-		15	1212-1649	42	1110-0061	
XJR1300 04-13			16	1212-1627	44	R210U-530-44-HA	
			16	R309U-530-16	45	R210U-530-45-HA	
			17	1212-0033	46	1110-0056	
			17	1212-1628	48	1110-0053	
XJR1300 99-03	530-		15	1212-1649	-	-	
			16	1212-1627			
			16	R309U-530-16			
			17	1212-0033			
			17	1212-1628			

¹ Ultralight



CHAINS



RR4 SRS ROAD RACE CHAIN

- 520 pitch that is developed exclusively for Superbike racing applications
- Utilizes Renthal's Self Regulating Seal (SRS) technology to increase the service life of the chain in road applications; enhances chain flexibility for smoother operation
- Features high-alloy steel plates and pins, solid bushings and rollers, shot-peened side plates and gold sides
- Pre-stretched for less adjustment during break in
- Includes a pair of latex gloves for mess-free installation
- Available in 520 pitch only, average tensile strength: RR4 SRS 520 36,5 kN (8206 lbs)
- Rivet only link included



DESCRIPTION	PART #
520 RR4 SRS	
110 links	1223-0091
120 links	1223-0092

DESCRIPTION	PART #
520 RR4 SRS (CONT)	
130 links	1223-0093

DESCRIPTION	PART #
REPLACEMENT MASTER LINK	
Rivet-link	1225-0088

R4 SRS ROAD CHAIN

- Specially developed sealed ring chain utilizes Renthal's Self Regulating Seal (SRS) technology to increase the service life of the chain in road applications; enhances chain flexibility for smoother operation
- Features high-alloy steel plates and pins, solid bushings and rollers, shot-peened side plates and gold sides
- Comes pre-stretched for less adjustment during break in
- Comes with a pair of latex gloves for mess-free installation
- Rivet only link included



520 R4 SRS

- Average tensile strength 35,9 kN (8092 lbs)
- Ideal for street bikes up to 1000cc

DESCRIPTION	PART #
520 R4 SRS	
110 links	1223-0082
120 links	1223-0083
130 links	1223-0084
REPLACEMENT MASTER LINK	
Rivet-type	1225-0085

525 R4 SRS

- Average tensile strength 40,9 kN (9217 lbs)
- Ideal for street bikes up to 1300cc

PART #	# OF LINKS
525 R4 SRS	
110 links	1223-0085
112 links	1224-0194
114 links	1224-0192
120 links	1223-0086
130 links	1223-0087
REPLACEMENT MASTER LINK	
Rivet-type	1225-0086

530 R4 SRS

- Average tensile strength 41,5 kN (9330 lbs)
- Ideal for street bikes up to 1300cc

PART #	# OF LINKS
530 R4 SRS	
110 links	1223-0088
120 links	1223-0089
130 links	1223-0090
REPLACEMENT MASTER LINK	
Rivet-type	1225-0087

520 R3-3 SRS CHAIN

- Renthal's SRS (Self-Regulating Seals) system increases service life of chain
- Comes pre-stretched for less adjustment during break in
- Rivet link has been changed to a hollow end to facilitate easier installation that does not require a Quad Stake Rivet tool to install
- High-carbon alloy steel pins, solid bushings and rollers, and shot peening of plates and rollers for increased fatigue resistance
- 520 pitch; average tensile strength 34,8 kN (7820 lbs)



DESCRIPTION	PART #
520 R3-3 SRS	
110 links	1223-1202
120 links	1223-1203

DESCRIPTION	PART #
520 R3-3 SRS (CONT)	
114 links	1223-1379
130 links	1223-1380

DESCRIPTION	PART #
REPLACEMENT MASTER LINK	
Rivet-type	1222-0454



Silver

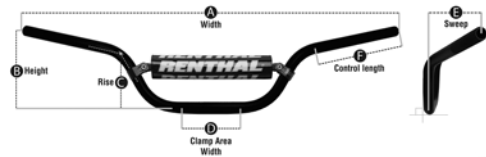

Black

HANDLEBARS

- Exclusive aerospace aluminum alloy is precisely engineered for the best combination of strength and fatigue reduction
- Each bar features an anodized corrosion-resistant finish
- Include bar pad

FITS MODEL	SILVER	BLACK
HONDA		
TRX250R Fourtrax 86-89	R6151-SI	-
TRX400EX/X Fourtrax/Sportrax 99-13	R7871-SI	R7871BK
TRX450R Sportrax 04-11	R7871-SI	R7871BK
KAWASAKI		
KFX400 03-06	R7871-SI	R7871BK
SUZUKI		
LT-Z400 Quad Sport Z 03-14	R7871-SI	R7871BK
YAMAHA		
YFS200 Blaster 88-06	R6361-SI	-

FITS MODEL	SILVER	BLACK
YAMAHA (CONT)		
YFM250 Raptor 11-13	R607-01-SI	0601-0095
YFM350 Raptor 04-13	R6361-SI	-
YFZ350 Banshee 87-06	R6361-SI	-
YFZ450 04-05	0601-0033	0601-0032
YFM660R Raptor 01-05	R607-01-SI	0601-0095
YFM700 Raptor 06-12	0601-0456	-
RACE STYLE		
Racing bars (all)	R7811-SI	-

ATV HANDLEBAR SPECIFICATIONS

HANDLEBAR PART #	A - WIDTH (MM)	B - HEIGHT (MM)	C - RISE (MM)	D - CLAMP AREA WIDTH (MM)	E - SWEEP (MM)
0601-0032, 0601-0033	773	109	92	105	96
0601-0456	790	142	112	120	90
R607-01, 0601-0095	790	141	110	80	97

HANDLEBAR PART #	A - WIDTH (MM)	B - HEIGHT (MM)	C - RISE (MM)	D - CLAMP AREA WIDTH (MM)	E - SWEEP (MM)
R6151	772	179	110	115	89
R6361	782	162	110	110	93
R7811	812	149	96	125	76
R7871	795	143	107	120	92



Black



Red



Titanium



Blue

FATBAR™ HANDLEBARS

- Aluminum alloy, with a no-brace design and 5.0 mm wall thickness at the bends to add strength
- 1 1/8" clamping area reduces slippage
- Combine excellent strength with resilience
- Laser-etched positioning grid; knurled bar end prevents grip slippage
- Shot-peened, anodized finish resists corrosion
- Include bar pad

FITS MODEL	COLOR	PART #	FITS MODEL	COLOR	PART #
KAWASAKI			YAMAHA		
KFX450R 08-15	■ Titanium	0601-0629	YFZ450R/X 07-16	■ Titanium	0601-1174
	■ Black	0601-0630		■ Black	0601-1173

BEND	BLACK	TANIUM	RED	BLUE
Reed/Windham	R603-01-BK	R603-01-TT	0601-0230	0601-0233
RC Bend/Windham	R604-01-BK	R604-01-TT	0601-0231	0601-0234
CR High	R605-01-BK	R605-01-TT	0601-0232	0601-0235
RC High Bend	R609-01-BK	R609-01-TT	0601-0601	0601-0602
RC Mini/85cc	R671-01-BK	-	-	-
RM/RMZ 06-13/KTM 06-12	R672-01-BK	R672-01-TT	-	-
Enduro Bend	R745-01-BK	-	-	-

HANDLEBAR SPECIFICATIONS

DESCRIPTION	RENTHAL BEND #	A - WIDTH (MM)	B - HEIGHT (MM)	C - RISE (MM)	D - CLAMP AREA WIDTH (MM)	E - SWEEP (MM)
0601-0629, 0601-0630	814	769	96	64	120	72
0601-1174, 0601-1173	819	784	105	70	140	86
Reed/Windham	603	803	92	56	100	57
RC Bend	604	802	99	65	105	54
CR High	605	795	95	70	115	62

DESCRIPTION	RENTHAL BEND #	A - WIDTH (MM)	B - HEIGHT (MM)	C - RISE (MM)	D - CLAMP AREA WIDTH (MM)	E - SWEEP (MM)
RC High Bend	609	802	119	80	105	54
RC Mini/85cc	671	740	118	83	85	42
RM/RMZ 06-13/ KTM 09-12	672	796	80	55	125	57
Enduro Bend	745	780	99	65	115	54



CROSSBAR PADS AND GRIPS



CROSSBAR PADS

- Durable PVC cover
- High-density injection molded foam to reduce rider injury
- Extremely lightweight
- Hook-and-loop fastening
- Power-wash proof permanent graphics
- Sold individually

COLOR	LENGTH	PART #	COLOR	LENGTH	PART #	COLOR	LENGTH	PART #
(A) ■ Black	8.5"	C0311-BK	■ Blue	10"	C0611-BU	(G) □ ■ White/blue	10"	0601-0457
(B) ■ Blue	8.5"	C0311-BU	(D) ■ Green	10"	C0611-GN	(H) ■ ■ Black/red	10"	0601-0458
(C) □ ■ White/green	8.5"	0601-0461	(E) ■ Red	10"	C0611-RD	(I) □ ■ White/red	10"	0601-0459
■ Black	10"	C0611-BK	(F) ■ Yellow	10"	C0611-YL	(J) □ ■ White/green	10"	0601-0460

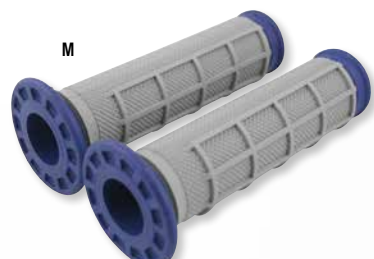
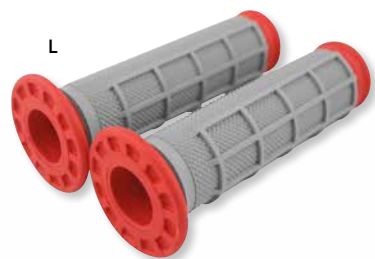
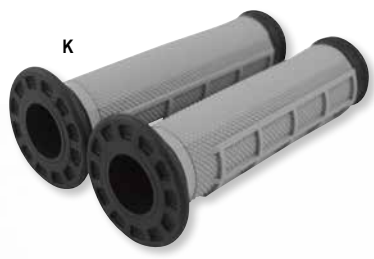

ATV DUAL-COMPOUND GRIPS

- ATV-specific grips feature a smaller inner flange and two grips of the same diameter for thumb throttle use
- Combine the durability of Renthal firm compound grips with the feel and absorption qualities of Renthal soft grips
- Firm compound is used for the flange, inner sleeve and outer end of the grip for maximum durability
- Soft compound used for the outer layer of the grip, which is in direct contact with the palm, fingers and thumb
- Half waffle design
- For use with thumb throttle
- For 7/8" bars; 4 9/16" L
- Sold in pairs

COLOR	PART #	COLOR	PART #	COLOR	PART #
(K) ■ Black	0630-0455	(L) ■ Red	0630-0456	(M) ■ Blue	0630-0457

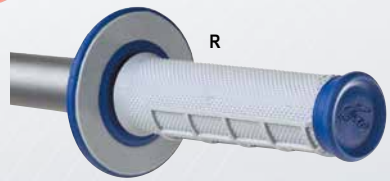
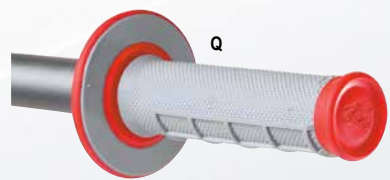
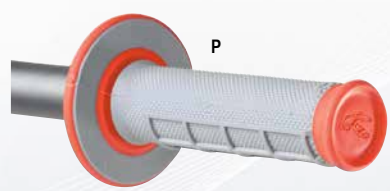

DUAL-COMPOUND GRIPS

- Renthal dual-compound grips combine the durability of Renthal's firm compound grips with the feel and absorption qualities of the Renthal range of softer compound grips
- Firm compound is used for the flange, inner sleeve and outer-end of the grip for maximum durability, softer compounds are used for the outer diameter of the grip, which is in direct contact with the palm, fingers and thumb
- For use with twist throttle
- For 7/8" bars; 4 1/2" L
- Sold in pairs

DESCRIPTION	COLOR	PART #	DESCRIPTION	COLOR	PART #	DESCRIPTION	COLOR	PART #
(N) Half waffle	■ Gray	RG151	(P) Half waffle	■ Orange	0630-0006	(R) Half waffle	■ Blue	0630-0008
(O) Full waffle	■ Gray	RG152	(Q) Half waffle	■ Red	0630-0007			

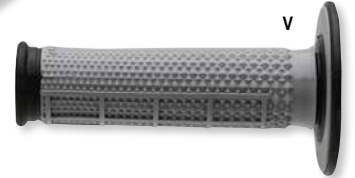
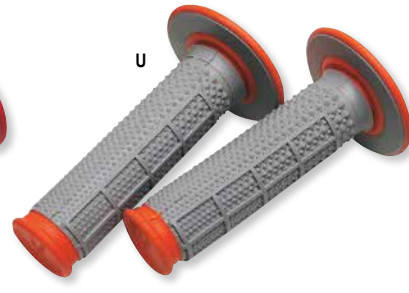
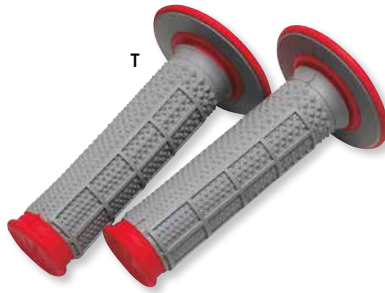

TAPERED DUAL-COMPOUND GRIPS

- Oversized thumb diameter tapers to standard size at end to match contours of a closed fist for maximum comfort and control
- Increased material in thumb area for more cushioning and damping against vibration without reducing control
- Soft compound used for the outer diameter of the grip, which is in direct contact with the palm, fingers and thumb
- Firm compound used for the flange, inner sleeve and outer-end of the grip for maximum durability

- Offer the ultimate combination of comfort and durability
- For use with twist throttle
- For 7/8" bars; 4 5/8" L
- Sold in pairs

COLOR	PART #	COLOR	PART #	COLOR	PART #	COLOR	PART #
(S) ■ Blue	0630-0262	(T) ■ Red	0630-0263	(U) ■ Orange	0630-0264	(V) ■ Gray	RG154

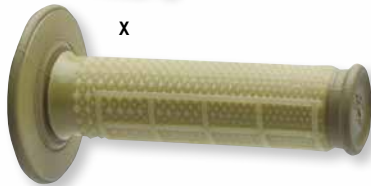
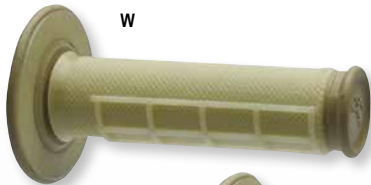

REINFORCED DUAL-COMPOUND GRIPS

- Softest, tackiest and longest-lasting Renthals grips ever
- Feature resin particles in a soft compound thermoplastic elastomer
- Last three times longer than regular soft grips
- Half-waffle design; for use with twist throttles
- Available in standard and tapered style
- For 7/8" bars; 4 5/8" L
- Sold in pairs

ATV REINFORCED DUAL-COMPOUND GRIPS

- ATV-specific grips feature a smaller inner flange and two grips of the same diameter for thumb throttle use
- Softest, tackiest and longest-lasting Renthals grips ever
- Feature reinforced fibers in a soft, dual-compound thermoplastic elastomer
- Last three times longer than regular soft grips
- Available in half-waffle design in natural color
- For 7/8" bars; 4 5/8" L
- Sold in pairs

DESCRIPTION	PART #	DESCRIPTION	PART #
(W) Dual compound	0630-0265	ATV Dual compound	0630-0458
(X) Dual compound tapered	0630-0266		

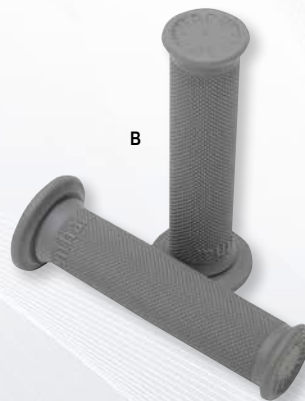
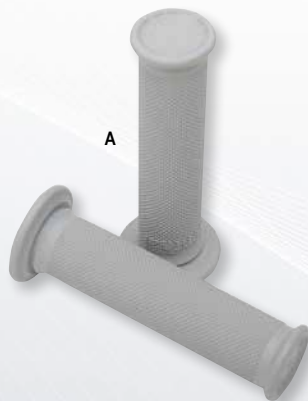

ATV ALL-DIAMOND GRIPS

- 7/8" ID for all ATVs with thumb throttles
- For ATVs, watercraft and mountain bikes
- Choice of three compounds: firm (like stock), medium and soft
- Small flange design will not interfere with controls
- 4 1/2" L

DESCRIPTION	PART #	DESCRIPTION	PART #	DESCRIPTION	PART #
(A) Soft	RG06S	(B) Medium	RG06M	(C) Firm	RG06F



GRIPS



ALL-DIAMOND MX GRIPS

- Firm compound is the same as stock
- Medium compound is for better traction and comfort
- Soft compound is ideal for maximum traction
- For 7/8" bars; twist throttle; 4 1/8" L
- Sold in pairs

DESCRIPTION	PART #	DESCRIPTION	PART #
Soft	RG04S	(D) Firm	RG04F
Medium	RG04M		

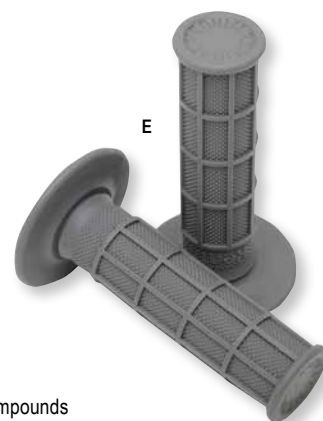

ALL-WAFFLE GRIPS

- Designed after the CR Honda grip
- Available in soft, medium and firm compounds
- For use with twist throttles
- For 7/8" bars; twist throttle; 4 1/8" L
- Sold in pairs

DESCRIPTION	PART #	DESCRIPTION	PART #
Soft	RG01S	Firm	RG01-F
(E) Medium	RG01-M		

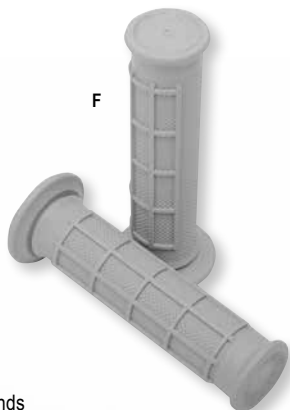

HALF WAFFLE GRIPS

- Waffle pattern in finger area for traction, smooth on palm side to reduce blisters
- Available in soft, medium and firm compounds
- Available for twist or thumb throttles
- For 7/8" bars; 4 1/2" L
- Sold in pairs

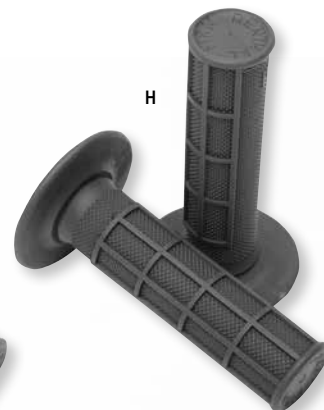
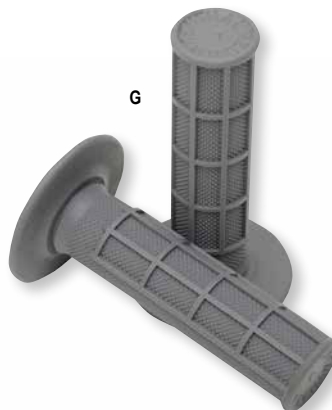

DESCRIPTION	TWIST THROTTLE	THUMB THROTTLE
(F) Soft	RG02S	RG111

DESCRIPTION	TWIST THROTTLE	THUMB THROTTLE
(G) Medium	RG02-M	RG112

DESCRIPTION	TWIST THROTTLE	THUMB THROTTLE
(H) Firm	RG02-F	RG113

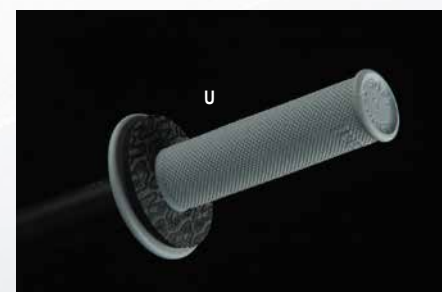
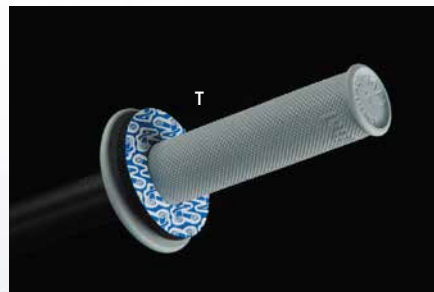
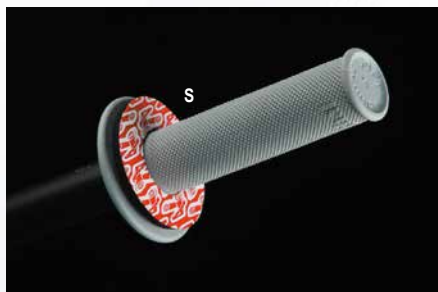

GRIP DONUTZ

- Help prevent blisters
- Add a cool factory look
- Sold in pairs

COLOR	PART #
(S) Red	0630-0079

COLOR	PART #
(T) Blue	0630-0080

COLOR	PART #
(U) Gray	0630-0081



MOTO HANDGUARDS

- Excellent protection against rocks and roost
- Lightweight, dual-compound molded plastic shield with flexible synthetic rubber edge
- Reinforced composite plastic mounting bracket offers protection and allows guard to flex in the event of a crash
- Mounts independently of perches for versatility and does not interfere with controls
- White color
- Includes blue, black and red sticker kits; other sticker kits also available (sold separately)
- Sold in pairs
- Made in the U.S.A.

DESCRIPTION	PART #	DESCRIPTION	PART #
(A) Moto handguards	0635-0877	OPTIONAL/REPLACEMENT STICKER KITS	
Repl. bracket	0635-0894	(B) Blue	4320-1327
		(C) Yellow	4320-1331

SPROCKETS

- CNC-machined from case-hardened and core-refined 655M13 nickel chromium steel
- Machined self-cleaning mud grooves at each tooth to help increase wear resistance
- Certain models available in ultralight design for a 10-15% weight savings



REAR SPROCKETS

- CNC-machined from a specially enhanced 7075-T6 aluminum alloy
- Machined self-cleaning mud grooves at each tooth to help increase wear resistance
- All rear sprockets are the ultralight design, making them 66% lighter than steel, yet incredibly durable
- Available in silver
- #1 sprocket used in supercross, motocross and offroad throughout the world

FITS MODEL	GEARING	FRONT SIZE	FRONT PART #	REAR SIZE	REAR PART #
HONDA					
ATC250R 86	13/39	13T	R308-520-13	36T	R223-36
TRX250R FourTrax 86-89	13/39			37T	R223-37
				38T	R223-38
				39T	R223-39
TRX250X FourTrax 87-88, 91-92	-	-	-	36T	R223-36
TRX300EX FourTrax/Sportrax 93-09				37T	R223-37
				38T	R223-38
				39T	R223-39
TRX400EX FourTrax/Sportrax 99-04	13/38	16T	R279-520-16	36T	R223-36
				37T	R223-37
				38T	R223-38
				39T	R223-39
TRX400EX FourTrax/Sportrax 05-14	14/38	13T	1212-0246	36T	R223-36
		14T	1212-0247	37T	R223-37
				38T	R223-38
				39T	R223-39
TRX450R/ER 04-14	14/38	13T	R253-520-13	36T	R223-36
		13T	R253U-520-13	37T	R223-37
		14T	R253-520-14	38T	R223-38
		15T	R253-520-15	39T	R223-39



SPROCKETS



SPROCKETS (CONT)

FITS MODEL	GEARING	FRONT SIZE	FRONT PART #	REAR SIZE	REAR PART #
KAWASAKI					
KFX400 03-06	14/40	13T	1212-0047	40T	R203-40
		14T	R432-520-14	42T	R203-42
		15T	1212-0049		
KFX450R 08-14	14/38	13T	1212-0310	36T	1211-0305
		14T	1212-0311	38T	1211-0307
		15T	1212-0312	36T	R223-36 ¹
				38T	R223-38 ¹
			40T	R223-40 ¹	
SUZUKI					
LT250R QuadRacer 85-92	12/42	12T	R255-520-12	40T	R203-40
		13T	R255-520-13	42T	R203-42
		14T	R255-520-14		
LT-Z400 QuadSport Z 03-08	14/40	13T	1212-0047	40T	R203-40
		14T	R432-520-14	42T	R203-42
		15T	1212-0049		
LT-Z400 QuadSport Z 09-14	14/40	13T	1212-0047	36T	1211-0221
		14T	R432-520-14	38T	1211-0223
		15T	1212-0049	40T	1211-2507
LT-R450 Quad Racer 06-09	14/36	13T	1212-0047	36T	1211-0221
		14T	R432-520-14	38T	1211-0223
		15T	1212-0049	40T	1211-2507
YAMAHA					
YFS200 Blaster 88-06	13/40	13T	R366520-13	40T	R130-40
		14T	R366520-14	41T	R130-41
				42T	R130-42
YFM250 Raptor 08-13	14/38	14T	1212-0501	36T	1211-0095
				37T	1211-0096
				38T	1211-0097
				39T	1211-0098
				40T	1211-0099
YFM350X Warrior 87-88	14/40	12T	R252-520-12	-	-
		13T	R252-520-13		
		14T	R252-520-14		
		15T	R252-520-15		
YFM350X Warrior 89-03	13/40	12T	R252-520-12	40T	R130-40
		13T	R252-520-13	42T	R130-42
		14T	R252-520-14		
		15T	R252-520-15		
YFZ350 Banshee 87-06	13/41	12T	R252-520-12	40T	R130-40
		13T	R252-520-13	42T	R130-42
		14T	R252-520-14		
		15T	R252-520-15		
YFM350 Raptor 04-16	14/40	12T	R252-520-12	36T	1211-0095
		13T	R252-520-13	37T	1211-0096
		14T	R252-520-14	38T	1211-0097
		15T	R252-520-15	39T	1211-0098
				40T	1211-0099
YFZ450 04-16	14/38	12T	R289-520-12	36T	1211-0095
		13T	R289-520-13	37T	1211-0096
		14T	R289-520-14	38T	1211-0097
		15T	R289-520-15	39T	1211-0098
				40T	1211-0099
YFZ450R/X 09-20	14/38	13T	1212-0210	36T	1211-0095
		14T	1212-0211	37T	1211-0096
		15T	1212-0212	38T	1211-0097
				39T	1211-0098
			40T	1211-0099	
YFM660 Raptor 01-05	13/40	12T	R289-520-12	40T	R130-40
		13T	R289-520-13	41T	R130-41
		14T	R289-520-14	42T	R130-42
		15T	R289-520-15		
YFM700 Raptor 06-20	14/38	13T	1212-0210	36T	1211-0095
		14T	1212-0211	37T	1211-0096
		15T	1212-0212	38T	1211-0097
				39T	1211-0098
			40T	1211-0099	

¹ Ultralight

520 R3 CHAIN

- Newest update to the R3 chain range
- Chain design does away with the "O-ring" and instead incorporates Renthal's SRS (Self-Regulating Seals) ring system to increase chain longevity
- Chain has been upgraded to the R4 ranges proven quad riveting manufacturing process
- Rivet link has also been changed to a hollow end to facilitate easier installation that does not require a Quad Stake Rivet tool to install
- High-carbon alloy steel pins, solid bushings and rollers, and shot peening of plates and rollers for increased fatigue resistance
- Clip type and rivet link included
- 520 pitch; average tensile strength 7420 lbs.



DESCRIPTION	PART #
104 links	1222-0450
114 links	1222-0451
116 links	1222-0452

DESCRIPTION	PART #
120 links	1222-0453
Repl. rivet link	1222-0454

520 R1 WORKS CHAIN

- Premium-quality, high-strength, lightweight non-O-ring chain
- Specifically designed for racing
- The choice when high strength, light weight and maximum power transfer are essential
- Shot-peened alloy steel side plates
- Ultra-high 7,644-lbs. average tensile strength
- Chamfered inner links reduce the chance of chain derailment
- Chromised bearing pins resist wear, especially under off-road conditions
- Extended bushings reduce friction, improve power transmission
- Gold-colored side plates help reduce corrosion
- Clip-type link included



DESCRIPTION	PART #
114 links	R1-520-114
116 links	R1-520-116
120 links	R1-520-120
Clip connecting link	R1-520-ML

520 R4 ATV Z-RING CHAIN

- Patented Z-ring seals dramatically increase the life of the chain by trapping specially formulated grease around the critical pin and bush area
- Larger diameter pins manufactured from specially enhanced steel improve the resistance to shock loads
- A quad riveting process on each pin increases the tensile strength of the chain
- Thicker inner and outer plates increase the fatigue life of the chain
- Recommended for engines up to 900cc
- Tensile strength 7,868 lbs.
- Latex gloves included for mess-free installation
- Clip type and rivet link included



DESCRIPTION	PART #
100 links	1224-0023
110 links	1224-0024
120 links	1224-0025

DESCRIPTION	PART #
Clip-type connecting link	1225-0091
O-ring rivet link	1225-0090



DISTRIBUTED BY

PARTS
EUROPE

Tel.: +49 (0) 6501 9695 - 2000
Fax: +49 (0) 6501 9695 - 2650
E-Mail: sales@partseurope.eu
Web: www.partseurope.eu