

2019

CATALOG



NK
NEKEN®

WWW.NK-NEKEN.COM

VARIABLE DIAMETER HANDLEBARS

WITH CONICAL DESIGN

- 7010 T6 aluminum aerospace quality
- Oversize bar made with a variable diameter and wall thickness
- 1 1/8" (28,6 mm) diameter in the clamping area
- 7/8" (22 mm) diameter at the control ends
- 40% lighter and stronger than a classic bar
- Laser etched to aid in handlebar centering and indexing
- Knurled clutch side for better grip hold
- Bar pad included

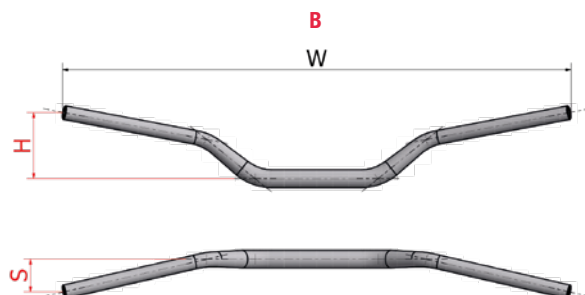
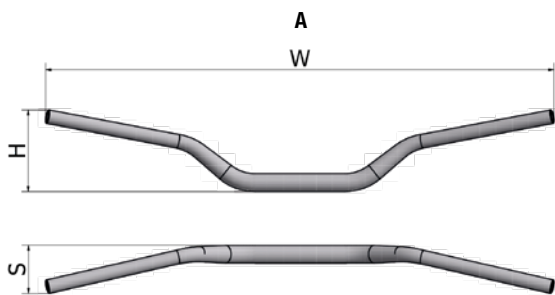

DIMENSIONS (MM)

DESCRIPTION	PART #	COLOR	WIDTH	A		B	
				HEIGHT	SWEEP	HEIGHT	SWEEP
85 LOW	0601-2899	Handlebar white, pad white	754	102	70	75	50
	0601-2900	Handlebar white-blue, pad blue	754	102	70	75	50
	0601-3745	Handlebar orange-blue, pad blue	754	102	70	75	50
	0601-3047	Handlebar USA, pad white	754	102	70	75	50
	0601-3329	Handlebar black-white, pad white	754	102	70	75	50
	0601-3746	Handlebar Factory Replica, pad black-yellow	754	102	70	75	50
	0601-3747	Handlebar fluo orange, pad orange-white	754	102	70	75	50
	0601-3748	Handlebar light blue, pad light blue-white	754	102	70	75	50
	0601-3749	Handlebar black, pad yellow-black	754	102	70	75	50
	0601-3750	Handlebar red, pad red-white	754	102	70	75	50
	0601-3751	Handlebar green, pad green-black	754	102	70	75	50
	0601-3752	Handlebar purple, pad purple-white	754	102	70	75	50
85 HIGH	0601-2903	Handlebar white, pad white	754	139	72	112	52
	0601-2904	Handlebar white-blue, pad blue	754	139	72	112	52
	0601-3753	Handlebar orange-blue, pad blue	754	139	72	112	52
	0601-3048	Handlebar USA, pad white	754	139	72	112	52
	0601-3330	Handlebar black-white, pad white	754	139	72	112	52
	0601-3754	Handlebar Factory Replica, pad black-yellow	754	139	72	112	52
	0601-3755	Handlebar fluo orange, pad orange-white	754	139	72	112	52
	0601-3756	Handlebar light blue, pad light blue-white	754	139	72	112	52
	0601-3757	Handlebar black, pad yellow-black	754	139	72	112	52
	0601-3758	Handlebar red, pad red-white	754	139	72	112	52
	0601-3759	Handlebar green, pad green-black	754	139	72	112	52
	0601-3760	Handlebar purple, pad purple-white	754	139	72	112	52



DIMENSIONS (MM)

DESCRIPTION	PART #	COLOR	WIDTH	A		B	
				HEIGHT	SWEEP	HEIGHT	SWEEP
QUAD HANDLEBAR	0601-2905	Handlebar fluo yellow, pad fluo yellow	808	146	76	119	56
	0601-2906	Handlebar white-blue, pad blue	808	146	76	119	56
	0601-3331	Handlebar black-white, pad white	808	146	76	119	56
	0601-3761	Handlebar fluo orange, pad orange-white	808	146	76	119	56
	0601-3762	Handlebar light blue, pad light blue-white	808	146	76	119	56
	0601-3763	Handlebar black, pad yellow-black	808	146	76	119	56
ORIGINAL YZF	0601-2907	Handlebar fluo yellow, pad fluo yellow	820	118	74	90	54
	0601-2910	Handlebar white, pad white	820	118	74	90	54
	0601-2911	Handlebar white-blue, pad blue	820	118	74	90	54
	0601-2912	Handlebar orange-blue, pad blue	820	118	74	90	54
	0601-3050	Handlebar USA, pad white	820	118	74	90	54
	0601-3332	Handlebar black-white, pad white	820	118	74	90	54
	0601-3436	Handlebar Factory Replica, pad black-yellow	820	118	74	90	54
	0601-3764	Handlebar fluo orange, pad orange-white	820	118	74	90	54
	0601-3765	Handlebar light blue, pad light blue-white	820	118	74	90	54
	0601-3766	Handlebar black, pad yellow-black	820	118	74	90	54
	0601-3767	Handlebar red, pad red-white	820	118	74	90	54
	0601-3768	Handlebar green, pad green-black	820	118	74	90	54
	0601-3769	Handlebar purple, pad purple-white	820	118	74	90	54
	0601-3909	Handlebar Japan, pad red-white	820	118	74	90	54
ALL BRANDS (121)	0601-2913	Handlebar fluo yellow, pad fluo yellow	815	132	73	105	52
	0601-2916	Handlebar white, pad white	815	132	73	105	52
	0601-2967	Handlebar white-blue, pad blue	815	132	73	105	52
	0601-2970	Handlebar orange-blue, pad blue	815	132	73	105	52
	0601-3051	Handlebar USA, pad white	815	132	73	105	52
	0601-3333	Handlebar black-white, pad white	815	132	73	105	52

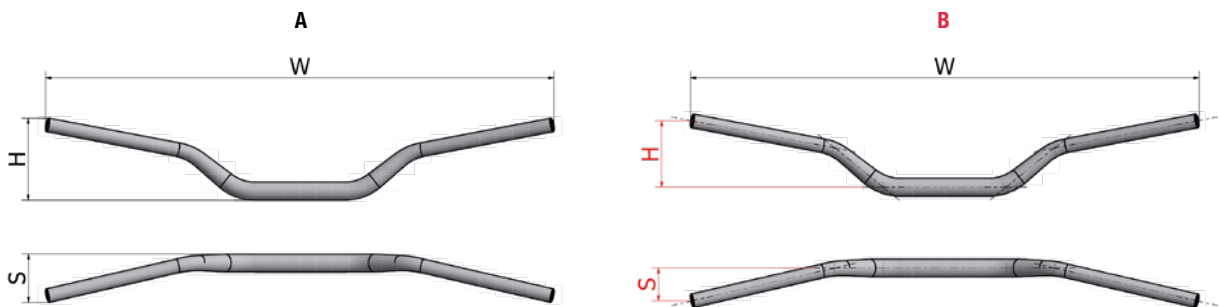

VARIABLE DIAMETER HANDLEBARS (CONT)

DESCRIPTION	PART #	COLOR	DIMENSIONS (MM)				
			WIDTH	A		B	
				HEIGHT	SWEEP	HEIGHT	SWEEP
ALL BRANDS (121) (CONT)	0601-3437	Handlebar Factory Replica, pad black-yellow	815	132	73	105	52
	0601-3770	Handlebar fluo orange, pad orange-white	815	132	73	105	52
	0601-3771	Handlebar light blue, pad light blue-white	815	132	73	105	52
	0601-3772	Handlebar black, pad yellow-black	815	132	73	105	52
	0601-3773	Handlebar red, pad red-white	815	132	73	105	52
	0601-3774	Handlebar green, pad green-black	815	132	73	105	52
	0601-3775	Handlebar purple, pad purple-white	815	132	73	105	52
	0601-3910	Handlebar Japan, pad red-white	815	132	73	105	52
ALL BRANDS (133)	0601-2918	Handlebar fluo yellow, pad fluo yellow	820	110	73	80	54
	0601-2921	Handlebar white, pad white	820	110	73	80	54
	0601-2971	Handlebar white-blue, pad blue	820	110	73	80	54
	0601-2974	Handlebar orange-blue, pad blue	820	110	73	80	54

VARIABLE DIAMETER HANDLEBARS (CONT)

DESCRIPTION	PART #	COLOR	DIMENSIONS (MM)					
			WIDTH	A		B		
				HEIGHT	SWEEP	HEIGHT	SWEEP	
ALL BRANDS (133) (CONT)	0601-3052	Handlebar USA, pad white	820	110	73	80	54	
	0601-3334	Handlebar black-white, pad white	820	110	73	80	54	
	0601-3438	Handlebar Factory Replica, pad black-yellow	820	110	73	80	54	
	0601-3776	Handlebar fluo orange, pad orange-white	820	110	73	80	54	
	0601-3777	Handlebar light blue, pad light blue-white	820	110	73	80	54	
	0601-3778	Handlebar black, pad yellow-black	820	110	73	80	54	
	0601-3779	Handlebar red, pad red-white	820	110	73	80	54	
	0601-3780	Handlebar green, pad green-black	820	110	73	80	54	
	0601-3781	Handlebar purple, pad purple-white	820	110	73	80	54	
	0601-3911	Handlebar Japan, pad red-white	820	110	73	80	54	
	K-BAR	0601-3782	Handlebar fluo yellow, pad yellow fluo	817	112	70	82	52
0601-3783		Handlebar white, pad white	817	112	70	82	52	
0601-3784		Handlebar white-blue, pad blue	817	112	70	82	52	
0601-3785		Handlebar orange-blue, pad blue	817	112	70	82	52	
0601-3788		Handlebar USA, pad white	817	112	70	82	52	
0601-3789		Handlebar black-white, pad white	817	112	70	82	52	
0601-3790		Handlebar Factory Replica, pad yellow-black	817	112	70	82	52	
0601-3791		Handlebar fluo orange, pad orange-white	817	112	70	82	52	
0601-3792		Handlebar light blue, pad light blue-white	817	112	70	82	52	
0601-3793		Handlebar black, pad black-yellow	817	112	70	82	52	
0601-3794		Handlebar red, pad red-white	817	112	70	82	52	
0601-3795		Handlebar green, pad green-black	817	112	70	82	52	
0601-3796		Handlebar purple, pad purple-white	817	112	70	82	52	
0601-3912		Handlebar Japan, pad red-white	817	112	70	82	52	
CR HIGH		0601-4704	Handlebar fluo yellow, pad fluo yellow	810	125	75	98	56
	0601-4705	Handlebar white, pad white	810	125	75	98	56	
	0601-4706	Handlebar white-blue, pad blue	810	125	75	98	56	
	0601-4707	Handlebar orange-blue, pad blue	810	125	75	98	56	
	0601-4708	Handlebar USA flag, pad white	810	125	75	98	56	
	0601-4709	Handlebar fact.replica, pad black K yellow	810	125	75	98	56	
	0601-4710	Handlebar fluo orange, pad orange-white	810	125	75	98	56	
	0601-4711	Handlebar red, pad red-white	810	125	75	98	56	
	0601-4712	Handlebar fluo green, pad green-black	810	125	75	98	56	
	ORIGINAL RMZ	0601-2923	Handlebar fluo yellow, pad fluo yellow	814	112	76	85	56
		0601-2925	Handlebar white, pad white	814	112	76	85	56
		0601-3053	Handlebar USA, pad white	814	112	76	85	56
0601-3335		Handlebar black-white, pad white	814	112	76	85	56	
0601-3439		Handlebar Factory Replica, pad black-yellow	814	112	76	85	56	
0601-3797		Handlebar fluo orange, pad orange-white	814	112	76	85	56	
0601-3798		Handlebar light blue, pad light blue-white	814	112	76	85	56	
0601-3799		Handlebar black, pad yellow-black	814	112	76	85	56	
0601-3800		Handlebar green, pad green-black	814	112	76	85	56	
0601-3801		Handlebar purple, pad purple-white	814	112	76	85	56	
0601-3913		Handlebar Japan, pad red-white	814	112	76	85	56	
PIT BIKE	0601-3340	Handlebar fluo yellow, pad fluo yellow	754	165	75	140	52	
	0601-3343	Handlebar white, pad white	754	165	75	140	52	
	0601-3345	Handlebar white-blue, pad blue	754	165	75	140	52	
	0601-3348	Handlebar orange-blue, pad blue	754	165	75	140	52	
	0601-3349	Handlebar USA, pad white	754	165	75	140	52	
	0601-3350	Handlebar black-white, pad white	754	165	75	140	52	

SFH VARIABLE DIAMETER HANDLEBARS WITH CONICAL DESIGN AND SMOOTH FEELING GRIPS

- 7010 T6 aluminum aerospace quality
- Oversize bar made with a variable diameter and wall thickness
- 1 1/8" (28,6 mm) diameter in the clamping area
- 40% lighter and stronger than a classic bar
- Laser etched to aid in handlebar centering and indexing
- Knurled clutch side for better grip hold
- Bar pad included
- Anodized gray aluminum
- Innovative Comfort for your hands

Note: Require the SFH Throttle Tube + SFH Grips – Sold Separately on the next page

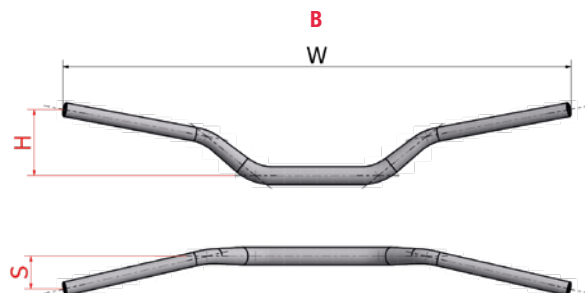
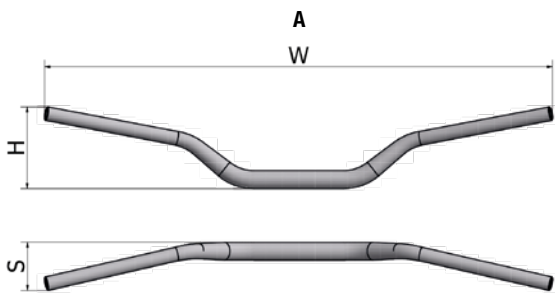

DIMENSIONS (MM)

DESCRIPTION	PART #	COLOR	WIDTH	A		B	
				HEIGHT	SWEEP	HEIGHT	SWEEP
ALL BRANDS (121)	0601-3997	Handlebar fluo yellow, pad fluo yellow	815	132	73	105	52
	0601-3998	Handlebar fluo orange, pad orange-white	815	132	73	105	52
	0601-3999	Handlebar fluo green, pad green-black	815	132	73	105	52
	0601-4000	Handlebar white, pad white	815	132	73	105	52
	0601-4001	Handlebar USA, pad white	815	132	73	105	52
	0601-4002	Handlebar light blue, pad light blue-white	815	132	73	105	52
	0601-4003	Handlebar black, pad yellow-black	815	132	73	105	52
	0601-4004	Handlebar red, pad red-white	815	132	73	105	52
	0601-4005	Handlebar Factory Replica, pad black-yellow	815	132	73	105	52

SFH VARIABLE DIAMETER HANDLEBARS (CONT)

DESCRIPTION	PART #	COLOR	DIMENSIONS (MM)					
			WIDTH	A		B		
				HEIGHT	SWEEP	HEIGHT	SWEEP	
ALL BRANDS (133)	0601-4006	Handlebar fluo yellow, pad fluo yellow	820	110	73	80	54	
	0601-4007	Handlebar fluo orange, pad orange-white	820	110	73	80	54	
	0601-4008	Handlebar fluo green, pad green-black	820	110	73	80	54	
	0601-4009	Handlebar white, pad white	820	110	73	80	54	
	0601-4010	Handlebar USA, pad white	820	110	73	80	54	
	0601-4011	Handlebar light blue, pad light blue-white	820	110	73	80	54	
	0601-4012	Handlebar black, pad yellow-black	820	110	73	80	54	
	0601-4013	Handlebar red, pad red-white	820	110	73	80	54	
	0601-4014	Handlebar Factory Replica, pad black-yellow	820	110	73	80	54	
	K-BAR	0601-4015	Handlebar fluo yellow, pad fluo yellow	817	112	70	82	52
		0601-4016	Handlebar fluo orange, pad orange-white	817	112	70	82	52
		0601-4022	Handlebar fluo green, pad green-black	817	112	70	82	52
		0601-4017	Handlebar white, pad white	817	112	70	82	52
		0601-4018	Handlebar USA, pad white	817	112	70	82	52
0601-4019		Handlebar light blue, pad light blue-white	817	112	70	82	52	
0601-4020		Handlebar black, pad yellow-black	817	112	70	82	52	
0601-4021		Handlebar red, pad red-white	817	112	70	82	52	
0601-4023		Handlebar Factory Replica, pad black-yellow	817	112	70	82	52	
ALL BRANDS (YZF)		0601-4024	Handlebar fluo yellow, pad fluo yellow	820	118	74	90	54
	0601-4025	Handlebar fluo orange, pad orange-white	820	118	74	90	54	
	0601-4031	Handlebar fluo green, pad green-black	820	118	74	90	54	
	0601-4026	Handlebar white, pad white	820	118	74	90	54	
	0601-4027	Handlebar USA, pad white	820	118	74	90	54	
	0601-4028	Handlebar light blue, pad light blue-white	820	118	74	90	54	
	0601-4029	Handlebar black, pad yellow-black	820	118	74	90	54	
	0601-4030	Handlebar red, pad red-white	820	118	74	90	54	
	0601-4032	Handlebar Factory Replica, pad black-yellow	820	118	74	90	54	

THROTTLE TUBE + GRIPS

- Designed to work with the SFH Handlebars
- Reduced diameter Throttle tube
- Cannot be used with standard handlebars
- Low friction material provides smooth operation
- SFH Grips Included
- Throttle cams included to fit most applications



0632-0812

REPLACEMENT GRIPS

- Designed to work with the SFH Handlebars & Throttle Tubes
- Reduced diameter Throttle tube, external diameter remains the same as standard grips
- Cannot be used with standard handlebars
- Half-Waffle pattern, soft and comfortable grips



0630-2125

DESCRIPTION	OUTSIDE Ø (MM)	PART #
Throttle Tube + Grey Grips (Standard outside diameter)	31	0632-0812
Throttle Tube + Black Grips (Standard outside diameter)	31	0632-0814
Throttle Tube + Grey Grips	28,5	0632-0834
Throttle Tube + Black Grips	28,5	0632-0835
Throttle Tube + Grey Grips	26,5	0632-0836
Throttle Tube + Black Grips	26,5	0632-0837

DESCRIPTION	OUTSIDE Ø (MM)	PART #
Replacement Grey Grips (Standard outside diameter)	31	0630-2125
Replacement Black Grips (Standard outside diameter)	31	0630-2264
Replacement Grey Grips	28,5	0630-2383
Replacement Black Grips	28,5	0630-2384
Replacement Grey Grips	26,5	0630-2385
Replacement Black Grips	26,5	0630-2386

VARIABLE DIAMETER HANDLEBARS

STANDARD COLORS

- 7010 T6 aluminum aerospace quality
- Variable bar made with a variable diameter and wall thickness
- 1 1/8" (28,6 mm) diameter in the clamping area
- 7/8" (22 mm) diameter at the control ends
- 40% lighter and stronger than a classic bar
- Laser etched to aid in handlebar centering and indexing
- Knurled clutch side for better grip hold
- Black bar pad included



Black



Silver

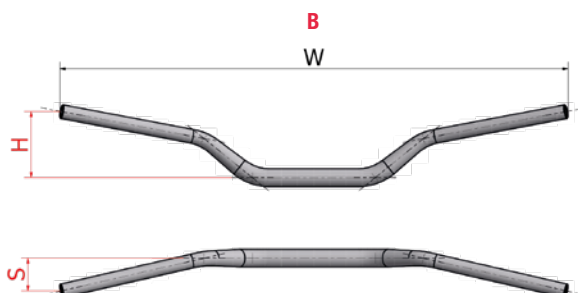
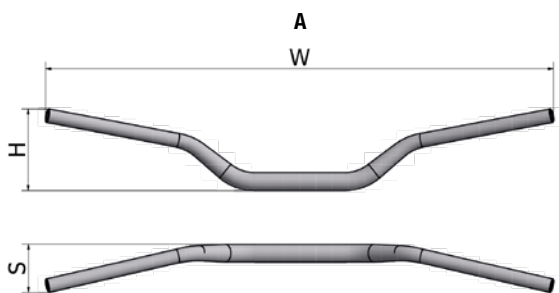

DIMENSIONS (MM)

DESCRIPTION	PART #	COLOR	WIDTH	A		B	
				HEIGHT	SWEEP	HEIGHT	SWEEP
85 HIGH	0601-2953	Handlebar black	754	139	72	112	52
	0601-2954	Handlebar silver	754	139	72	112	52
85 LOW	0601-2955	Handlebar black	754	102	70	75	50
	0601-2956	Handlebar silver	754	102	70	75	50
QUAD	0601-2957	Handlebar black	808	146	76	119	56
	0601-2958	Handlebar silver	808	146	76	119	56
ORIGINAL YZF	0601-2959	Handlebar black	820	118	74	90	54
	0601-2960	Handlebar silver	820	118	74	90	54
ALL BRANDS (121)	0601-2961	Handlebar black	815	132	73	105	52
	0601-2962	Handlebar silver	815	132	73	105	52
ALL BRANDS (133)	0601-2963	Handlebar black	820	110	73	80	54
	0601-2964	Handlebar silver	820	110	73	80	54
K-BAR	0601-3803	Handlebar black	817	112	70	82	52
	0601-3804	Handlebar silver	817	112	70	82	52
CR HIGH	0601-4713	Handlebar black	810	125	75	98	56
	0601-4714	Handlebar silver	810	125	75	98	56
ORIGINAL RMZ	0601-2965	Handlebar black	814	112	76	85	56
	0601-2966	Handlebar silver	814	112	76	85	56
PIT BIKE	0601-3802	Handlebar black	754	165	75	140	52

STANDARD 22 MM DIAMETER HANDLEBARS

- 7010 T6 aluminum aerospace quality
- Standard handlebar featuring a 5 mm inner wall thickness
- Added cross bar for better strength
- Laser etched to aid in handlebar centering and indexing
- Knurled clutch side for better grip hold
- Black Bar pad included



Blue



Red



Orange



Black



Silver

DIMENSIONS (MM)

DESCRIPTION	PART #	COLOR	WIDTH	A		B	
				HEIGHT	SWEEP	HEIGHT	SWEEP
50cc, 65cc, 85 LOW	0601-2926	Handlebar orange	750	110	71	90	50
	0601-2927	Handlebar titanium	750	110	71	90	50
	0601-2928	Handlebar silver	750	110	71	90	50
	0601-2929	Handlebar black	750	110	71	90	50
85cc HIGH	0601-2930	Handlebar orange	758	138	64	115	42
	0601-2931	Handlebar titanium	758	138	64	115	42
	0601-2932	Handlebar silver	758	138	64	115	42
	0601-2933	Handlebar black	758	138	64	115	42
MINI PLAY	0601-2934	Handlebar titanium	725	190	60	168	40
	0601-2935	Handlebar silver	725	190	60	168	40
	0601-2936	Handlebar black	725	190	60	168	40
QUAD HOBBY	0601-2937	Handlebar titanium	777	202	112	180	90
	0601-2938	Handlebar silver	777	202	112	180	90
	0601-2939	Handlebar black	777	202	112	180	90
QUAD RACE	0601-2940	Handlebar titanium	793	172	92	150	70
	0601-2941	Handlebar silver	793	172	92	150	70
	0601-2942	Handlebar black	793	172	92	150	70
250/450 CRF KXF	0601-2943	Handlebar titanium	810	122	76	100	54
	0601-2944	Handlebar silver	810	122	76	100	54
	0601-2945	Handlebar black	810	122	76	100	54
	0601-2946	Handlebar blue	810	122	76	100	54
	0601-2947	Handlebar red	810	122	76	100	54
250/450 CRF KXF LOW	0601-2948	Handlebar titanium	810	105	80	90	50
	0601-2949	Handlebar silver	810	105	80	90	50
	0601-2950	Handlebar black	810	105	80	90	50
	0601-2951	Handlebar blue	810	105	80	90	50
	0601-2952	Handlebar red	810	105	80	90	50

STANDARD VARIABLE DIAMETER STREET HANDLEBARS

- 7010 T6 aluminum aerospace quality
- Oversize bar made with a variable diameter and wall thickness
- 28,6 mm (1 1/8") diameter in the clamping area
- 22 mm (7/8") diameter at the control ends
- 40% lighter and stronger than a classic bar
- Laser-etched to aid in handlebar centering and indexing

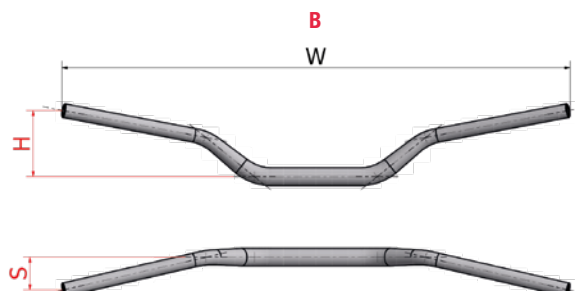
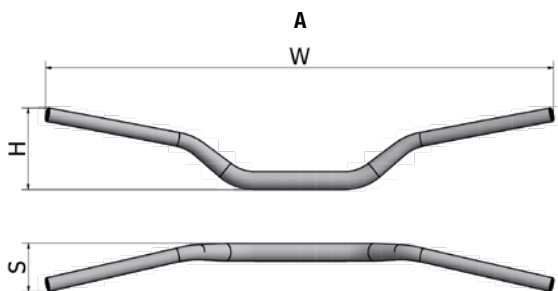

DIMENSIONS (MM)

DESCRIPTION	PART #	COLOR	WIDTH	A		B	
				HEIGHT	SWEEP	HEIGHT	SWEEP
LOW	0601-4104	Handlebar black	752	130	75	100	60
	0601-4105	Handlebar silver	752	130	75	100	60
MEDIUM	0601-4113	Handlebar black	752	145	82	122	60
	0601-4114	Handlebar silver	752	145	82	122	60
HIGH	0601-4122	Handlebar black	752	170	80	144	60
	0601-4123	Handlebar silver	752	170	80	144	60



STANDARD VARIABLE DIAMETER STREET HANDLEBARS

WITH CONICAL DESIGN

- 7010 T6 aluminum aerospace quality
- Oversize bar made with a variable diameter and wall thickness
- 28,6 mm (1 $\frac{1}{8}$ ") diameter in the clamping area
- 22 mm ($\frac{7}{8}$ ") diameter at the control ends
- 40% lighter and stronger than a classic bar
- Laser-etched to aid in handlebar centering and indexing



Fluo Yellow



Fluo Green



White-Blue



Light Blue



Orange-Blue



Fluo Orange



White-Green

DIMENSIONS (MM)

DESCRIPTION	PART #	COLOR	WIDTH	A		B	
				HEIGHT	SWEEP	HEIGHT	SWEEP
LOW	0601-4106	Handlebar Fluo yellow	752	130	75	100	60
	0601-4107	Handlebar Fluo orange	752	130	75	100	60
	0601-4108	Handlebar Light blue	752	130	75	100	60
	0601-4109	Handlebar Fluo green	752	130	75	100	60
	0601-4110	Handlebar White-Blue	752	130	75	100	60
	0601-4111	Handlebar White-Green	752	130	75	100	60
	0601-4112	Handlebar Orange-Blue	752	130	75	100	60
MEDIUM	0601-4115	Handlebar Fluo yellow	752	145	82	122	60
	0601-4116	Handlebar Fluo orange	752	145	82	122	60
	0601-4117	Handlebar Light blue	752	145	82	122	60
	0601-4118	Handlebar Fluo green	752	145	82	122	60
	0601-4119	Handlebar White-Blue	752	145	82	122	60
	0601-4120	Handlebar White-Green	752	145	82	122	60
	0601-4121	Handlebar Orange-Blue	752	145	82	122	60
HIGH	0601-4124	Handlebar Fluo yellow	752	170	80	144	60
	0601-4125	Handlebar Fluo orange	752	170	80	144	60
	0601-4126	Handlebar Light blue	752	170	80	144	60
	0601-4127	Handlebar Fluo green	752	170	80	144	60
	0601-4128	Handlebar White-Blue	752	170	80	144	60
	0601-4129	Handlebar White-Green	752	170	80	144	60
	0601-4130	Handlebar Orange-Blue	752	170	80	144	60

FLAT TRACK HANDLEBARS

- 7010 T6 aluminum aerospace quality
- Oversize bar made with a variable diameter and wall thickness
- 28,6 mm (1 1/8") diameter in the clamping area
- 22 mm (7/8") diameter at the control ends
- 40% lighter and stronger than a classic bar
- Laser-etched to aid in handlebar centering and indexing
- Knurled clutch side for better grip hold



Black



Fluo Yellow

DIMENSIONS (MM)

DESCRIPTION	PART #	COLOR	WIDTH	A		B	
				HEIGHT	SWEEP	HEIGHT	SWEEP
FLAT TRACK	0601-4435	Flat Track bar, Black	920	168	150	141	129
	0601-4436	Flat Track bar, Black and Fluo Yellow – Jared Mees Replica	920	168	150	141	129



OVERSIZED HANDLEBAR PADS

- Specifically designed for 28,6 mm handlebar (1 1/8")
- High density foam pad with high quality rubber cover
- Plastic shell under for a stabile fixation



Black-Light Blue



Black-Yellow



Black-Green



Black-Orange



Black-Red



Black-Pink



Red



Fluo Orange



Fluo Yellow



Blue



Black



Factory Replica



Light Blue



Fluo Green



Purple-White



Light Blue-White



Green-Black



Orange-White



Red-White



Yellow-Black



White

DESCRIPTION	PART #
Fluo Orange	0601-2890
Fluo Yellow	0601-2891
Fluo Green	0601-2892
White	0601-2893
Blue	0601-2894
Red	0601-2895

DESCRIPTION	PART #
Black	0601-2896
Light Blue	0601-3386
Orange-White	0601-3739
Light Blue-White	0601-3740
Yellow-Black	0601-3741
Red-White	0601-3742

DESCRIPTION	PART #
Green-Black	0601-3743
Purple-White	0601-3744
Factory Replica	0601-4131
Black-Orange	0601-4380
Black-Yellow	0601-4381
Black-Green	0601-4382

DESCRIPTION	PART #
Black-Light Blue	0601-4383
Black-Red	0601-4384
Black-Pink	0601-4437

OVERSIZED HANDLEBAR ENDURO PADS

- Specifically designed for Enduro bikes with 28,6 mm handlebar (1 1/8")
- High density foam pad with high quality rubber cover



Black



Red



Fluo Orange



Light Blue

DESCRIPTION	PART #
Fluo Orange	0601-3336

DESCRIPTION	PART #
Black	0601-3339

DESCRIPTION	PART #
Red	0601-3338

DESCRIPTION	PART #
Light Blue	0601-3337

REGULAR HANDLEBAR PADS

- For regular handlebar with crossbar
- Available in 21 cm (8,27") or 24,5 cm (9,65")
- Rubber cover high quality



Black-Orange



Black-Pink



Black-Yellow



Black-Light Blue



Black-Green



Black-Red



Fluo Orange



Fluo Green



Black



White



Fluo Yellow

DESCRIPTION	PART #
MINI (21 CM)	
Black	0601-2881
Fluo Yellow	0601-2882
White	0601-2883
Fluo Orange	0601-2884
Black-Orange	0601-4718
Black-Red	0601-4719
Black-Green	0601-4720
Black-Light Blue	0601-4721
Black-Yellow	0601-4722
Black-Pink	0601-4723

DESCRIPTION	PART #
STANDARD (24,5 CM)	
Black	0601-2885
Fluo Yellow	0601-2886
White	0601-2887
Fluo Orange	0601-2888
Fluo Green	0601-2889
Black-Orange	0601-4724
Black-Red	0601-4725
Black-Green	0601-4726
Black-Light Blue	0601-4727
Black-Yellow	0601-4728
Black-Pink	0601-4729

SFS

SMOOTH FEELING SYSTEM



SFS Air clamps have an exceptional shock absorbing capacity, this is created by an air/oil system and especially with a valve that enables the riders to regulate the air pressure.

With 10 mm stroke (A), NK SFS air clamp guarantees to riders more precision in riding, a longer physical freshness and an arm pump decrease.

NK SFS air clamp works in the same direction as the front fork but this system is more sensitive. It enables a reduction of impacts in hands, forearms, shoulders and help to choose easier trajectories.

The pneumatic control permits to choose the damping following your riding level and also following your category in motocross, supercross, or enduro.

In order to completely take advantage of the SFS clamps, complete instructions are delivered with it.

SFS TOP CLAMPS

- CNC machined from aerospace quality Tridium Alloy
- Handlebar clamp included (28,6 mm handlebar (1 1/8"))
- The industry's first air-adjustable, oil-damped suspended handlebar clamp, offering 10 mm of travel
- Improve the riding comfort, decrease the arm pump
- Developed in collaboration with top US MX/SX & MXGP teams
- No service required
- Torque settings noticed on clamps
- Patented in Europe and USA
- High pressure air pump (Part# 3805-0124) required to adjust the clamps

FITMENTS	COLOR	OFFSET	PART #
HONDA			
CRF 250R 14-17	Red	20 mm	0603-0672
CRF 450R 14-16			
CRF 250R 18-19	Red	22 mm	0603-0752
CRF 450R 17-19			
HUSQVARNA			
TC/FC 125/250/350/450 15-19	Black	22 mm	0603-0678
	Blue	22 mm	0603-0683
KAWASAKI			
KXF 250 14-19	Blue	23 mm	0603-0673
KXF 450 14-19	Blue	23 mm	0603-0674
KTM			
SX/SXF 125/250/350/450 13-19	Black	22 mm	0603-0677
	Orange	22 mm	0603-0682



FITMENTS	COLOR	OFFSET	PART #
SUZUKI			
RMZ 250 14-15	Red	21,5 mm	0603-0675
RMZ 250 16	Red	21,5 mm	0603-0681
RMZ 450 14-16	Red	21,5 mm	0603-0676
YAMAHA			
YZF 250/450 14-19	Blue	22 mm	0603-0671
YZF 250 16-18	Blue	25 mm	0603-0670
YZF 450 16-17			

SFS TRIPLE CLAMPS

- CNC-machined from aerospace quality 7075 T6 aluminum alloy
- Handlebar clamps included (For 28,6 mm handlebars (1½"))
- Easy to install; pre-pressed Pivot Works lower bearing included
- Developed in collaboration with top US MX/SX and MXGP teams
- Torque settings etched on the clamps
- Greater rigidity
- Anodized finish



FITMENTS	COLOR	OFFSET	PART #
HONDA			
CRF 250 13-16	Red	20 mm	0603-0590
CRF 450 09-16	Red	20 mm	0603-0590
CRF 450R 17-19	Red	22 mm	0603-0750
CRF 250R 18-19			
HUSQVARNA			
TC/FC 125/250/350/450 15-19	Blue	22 mm	0603-0659
KAWASAKI			
KX 85 14-18	Blue	Original	0603-0587
KXF 250 14-19	Blue	23 mm	0603-0585
KXF 450 14-19	Blue	23 mm	0603-0586

FITMENTS	COLOR	OFFSET	PART #
KTM			
SX/SXF 125/250/350/450 13-19	Orange	22 mm	0603-0658
SUZUKI			
RMZ 250 14-15	Red	21,5 mm	0603-0588
RMZ 250 16	Red	21,5 mm	0603-0679
RMZ 450 14-16	Red	21,5 mm	0603-0589
YAMAHA			
YZ 85 14-17	Blue	25 mm	0603-0592
YZF 250/450 14-19	Blue	22 mm	0603-0591
YZF 450 14-17	Blue	25 mm	0603-0669



SFS SPRING TOP CLAMPS

- Improves the riding comfort, decrease the arm pump
- Exceptional capacity to absorb small bumps and important impacts
- Works in the same direction as the front fork, no floating feeling
- CNC machined from aerospace quality 7075 T6 aluminum alloy
- Handlebar clamp included for 28,6 mm handlebar (1½")
- 10 mm of travel; 22 mm offset
- Torque settings indicated on clamps
- No service required
- Anodized finish

FITMENTS	COLOR	PART #
HUSQVARNA		
TC/FC 125/250/350/450 15-19	Blue	0603-0766
KTM		
SX/SX-F 125/250/350/450 13-19	Black	0603-0764
	Orange	0603-0765

SFS SPRING COMPLETE TRIPLE CLAMPS

- Improve the riding comfort, decrease the arm pump
- Exceptional capacity to absorb small bumps and important impacts
- Works in the same direction as the front fork, no floating feeling
- Suitable for every rider in motocross, supercross and enduro
- CNC-machined from aerospace quality 7075 T6 aluminum alloy
- Handlebar clamp included for 28,6 mm handlebar (1½")
- 10 mm of travel; 22 mm offset
- Offers greater rigidity than stock
- Torque settings indicated on clamps; lower bearing included
- Easy to install; pre-pressed Pivot Works lower bearing
- No service required
- Anodized finish

FITMENTS	COLOR	PART #
HUSQVARNA		
TC/FC 125/250/350/450 15-19	Blue	0603-0768
KTM		
SX/SX-F 125/250/350/450 13-19	Orange	0603-0767

STANDARD TRIPLE CLAMPS

- CNC-machined from aerospace quality 7075 T6 aluminum alloy
- Handlebar clamps included (For 28,6 mm handlebars (1 1/8"))
- Adjustable bar clamp mounting position
- Easy to install; pre-pressed Pivot Works lower bearing included
- Developed in collaboration with top US MX/SX and MXGP teams
- Torque settings etched on the clamps
- Greater rigidity
- Anodized finish

FITMENTS	COLOR	OFFSET	PART #
HONDA			
CRF 250 13-17	Red	20 mm	0603-0596
CRF 250 13-17	Red	24 mm	0603-0597
CRF 250 18-19	Red	22 mm	0603-0751
CRF 450 13-16	Red	20 mm	0603-0596
CRF 450 13-16	Red	24 mm	0603-0597
CRF 450R 17-19	Red	22 mm	0603-0751
HUSQVARNA			
TC 85 15-19	Blue	Original	0603-0740
TC/FC 125/250/350/450 15-19	Blue	22 mm	0603-0661
KAWASAKI			
KX 85 14-19	Blue	Original	0603-0599
KXF 250/450 14-19	Blue	23 mm	0603-0598
KTM			
SX 65 13-19	Orange	Original	0603-0642
SX 85 15-19	Orange	Original	0603-0641
SX/SXF 125/250/350/450 13-19	Orange	22 mm	0603-0660



FITMENTS	COLOR	OFFSET	PART #
SUZUKI			
RMZ 250 14-15	Red	21,5 mm	0603-0600
RMZ 250 16	Red	21,5 mm	0603-0680
RMZ 450 14-16	Red	21,5 mm	0603-0601
YAMAHA			
YZ 85 14-17	Blue	Original	0603-0595
YZF 250/450 14-19	Blue	22 mm	0603-0593
YZF 250/450 14-19	Blue	25 mm	0603-0594
YZF 250 18-19	Blue		



UNIVERSAL MOUNTING AND HANDLEBAR CLAMPS

- Allows the mounting of an oversize or standard diameter handlebar
- Handlebar clamp adjustable height 30, 35, 40, 45 mm



0603-0608

FITMENTS AND DESCRIPTION	THREAD (MM)	DIAM. (MM)	PART #
HONDA			
CRF 250 13-17	–	22	0603-0602
CRF 250 13-17	–	28,6	0603-0605
CRF 450 09-16	–	22	0603-0602
CRF 450 09-16	–	28,6	0603-0605

FITMENTS AND DESCRIPTION	THREAD (MM)	DIAM. (MM)	PART #
UNIVERSAL			
Standard diameter	10	22	0603-0603
Standard diameter	12	22	0603-0604
Oversized	10	28,6	0603-0606
Oversized	12	28,6	0603-0607
Universal Mounting	–	–	0603-0608



0630-2387



0630-2388



0630-2389



0630-2390



0630-1516



0630-1517



0630-1920



0630-1921

GRIPS

- Soft, comfortable grips
- For use with twist throttles

DESCRIPTION	PART #
HALF WAFFLE	
Black	0630-1516
Grey	0630-1517

DESCRIPTION	PART #
DIAMOND	
Black	0630-1920
Grey	0630-1921
Blue	0630-2387
White	0630-2388
Yellow	0630-2389
Red	0630-2390

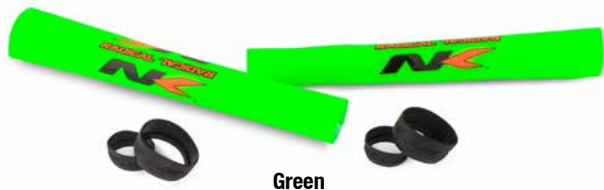

Green



Yellow

BAR COVER KIT

- The kit includes: two vinyl sleeves + 4 black rubber rings
- 6 colours to choose from: green / yellow / red / white / blue / orange
- Applies to all variable diameter handlebars (on all brands)
- Easy to mount: The vinyl cones slide on The handlebar handle using soapy water

COLOR	PART #
Green	0636-0144
Yellow	0636-0145
Red	0636-0146

COLOR	PART #
White	0636-0147
Blue	0636-0148
Orange	0636-0149



Orange

Black

T-SHIRTS

- Tee-Shirts are 100% polyester

SIZE	PART #
ORANGE	
S	3030-17861
M	3030-17862
L	3030-17863
XL	3030-17864

SIZE	PART #
BLACK	
S	3030-17865
M	3030-17866
L	3030-17867
XL	3030-17868



Black

Black-Orange

HATS

- Hats have only one size

SIZE	PART #
BLACK-ORANGE	
One Size	2501-3091

SIZE	PART #
BLACK	
One Size	9904-1390



HIGH PRESSURE AIR PUMP

- Easy to use
- Aluminum construction
- Measures 0-300 psi and 0-21 bar
- Button to micro adjust the air pressure
- Overall length: 300 mm

DESCRIPTION	PART #
Hi Press Air Pump	3805-0124



White

Black

Orange

BEANIES

- 100% acrylic
- One size fits most
- Stitched on logo

COLOR	PART #
Black	2501-2654
White	2501-2655
Orange	2501-2656

MK NEKEN®

WWW.NK-NEKEN.COM



DISTRIBUTED BY

**PARTS
EUROPE**

WWW.PARTSEUROPE.EU

Parts Europe GmbH
Conrad-Röntgen-Straße 2
54332 Wasserliesch/Trier (Germany)
Tel.: +49 (0) 6501 9695 - 2000
Fax: +49 (0) 6501 9695 - 2650
E-Mail: sales@partseurope.eu